

Waterjet cutting and milling

THE OPTIMUM SYSTEM
FOR EVERY APPLICATION

We have been using and developing the latest CNC technologies for more than 10 years now, offering the highest quality and production rate to our customers.

Be it complete equipment, individual units, processing technology or lease-work, we are sure that the speed, productivity, customizing options and our competitive prices will be appealing to you.

Certain items of our developed prototypes are commercially available, while others are integrated into our lease-work service. This way our production, distribution and end-user experiences guarantee an excellent cooperation with our customers.



Flame cutting



Laser cutting



Milling



Plasma cutting



Waterjet cutting

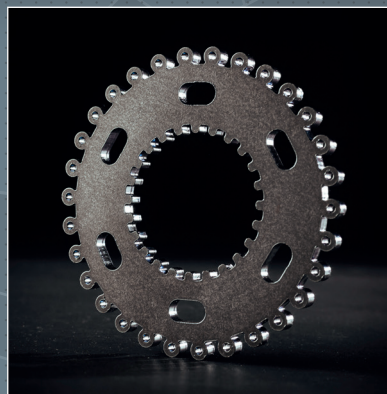
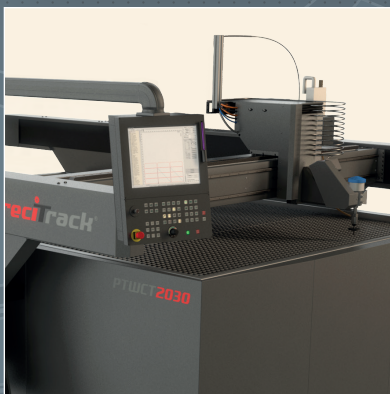

From complete equipments to components

We offer customized solutions for the complete installation of any technology suited for your individual production demands. In addition to that we offer individual units to several technologies, representing many international companies.

Spare part production

Our company produces different spare parts from materials ranging from plastics to aluminium alloys and tempered steel. By using several technologies, we have the option to cut and process every material.

Service

We offer contract-based preventive maintenance mainly for our own equipment but also for systems built by other companies, as well. Our team and fleet of ten service cars are at your disposal any time you need engineering help.

Content

MECHANICS

PreciTrack coordinate system	2
------------------------------------	---

WATERJET CUTTING

System technology, 1-2-3 dimensional waterjet cutting.....	4
4000 bar vs. 6000 bar	6
The Intensifier	8
Technical data	10

COMPLETE WATERJET CUTTING EQUIPMENT

PreciTrack PTW2030	12
--------------------------	----

EQUIPMENT – 6200 BAR

STREAMLINE™ PRO-2 60/125	13
ACTIVE AUTOLINE™ PRO + ACTIVE IDE™ PRO	15
AQUALINE PRO	16

EQUIPMENT – 4136 BAR

STREAMLINE™ SL-V 200 Plus	17
STREAMLINE™ SL-V 50/100 Plus	18
STREAMLINE™ SL-V 50 Classic	19
STREAMLINE™ SL-V 15 STD	20
JETLINE™ JL-I 50	21

SKID MOUNTED PUMPS FOR SYSTEM INTEGRATION

NEOLINE™ NL-I 40 OEM	22
STREAMLINE™ SL-V 50 OEM	23

CUTTING HEADS

AQUALINE I	24
ACTIVE AUTOLINE™ II + ACTIVE IDE™ II	25

OPTIONS AND ACCESSORIES

Pump options	27
ABRALINE	28
FEEDLINE	29
FEEDLINE PRECISION	30
BOOSTERLINE	32

MILLING TECHNOLOGY

General description of milling	33
PreciTrack PTM2030 complete milling equipment	34
JÄGER High frequency spindles.....	35
HSD High frequency spindles.....	40

coordinate track equipped with NCT control system

Precirack® coordinate system



Features

- Path system suitable to be enlarged in modular way
- Structure made of a special alloy
- 3-component nano-composite lining
- Surprisingly light, yet, extraordinary rigid design
- Joint planes machined with high accuracy
- Axes and machine stay-plates measured by laser interferometer
- A,B,Z axes for 3 to 5-axis machining
- Speed of axes of 130 m/min with 1 G acceleration
- 0,01 mm accuracy of positioning and repetition
- Space measuring system with 3 micrometer scale division
- GANTRY axis synchronism
- Surface treated precision drive mechanism, with inclined cogging
- Compact technology-carrier carriage with threefold linear guiding and zero pitching
- Protection of saddle against pollution by means of rubber mantle made of fire- and water resistant elements
- Sectioned cabin within the work area, operator console of ergonomic design with spacious margin
- Space saving design, easy transportability, installation possibility on extreme sites.

Modular design

A system suitable to be built of elements that offers a number of possibilities in respect of both the work space and equipment. The useful work area can be increased in a cost-effective way at any time up to as high as 6000 x 30 000 mm size. The processing technology can be changed even posteriorly and the machine can be enlarged with other optional features. Operator cabin within the work area and work benches of various design are also available on request

Light and compact design

It is made of structural elements composed of special alloy by using individual welding technology. It has a rigid and vibration-free crosswise bridge structure of optimized centre of gravity. An integrated longitudinal saddle is built on its legs fit into another strutted in several directions.

Preciseness

The stay plates of the structure are levelled by means of a laser interferometer. All of its components are levelled by milling on the whole surface of junction points. It is driven along the XY axis by means of a surface-treated precision gear-rack of inclined cogging made of strengthened alloy suitable to be ranked. The drive along the Z axis is backlash-free, provided with a high precision ball spindle. In case of AB rotating axles, a high precision backlash-free wave-drive will be built-in. The parallelism of Gantry axles is measured by means of microscope-aided threads. Linear leads along each axis and threefold guide in crosswise direction are mounted. The drives are of ground gears and the mechanical structure is assembled with high precision.

Advanced control- and drive system

NCT and Beckhoff controls

- Intelligent control software with intuitive graphic interface
- Professional operator console with touch screen
- Handling of as much as 64K axis and 8 virtual machine simultaneously
- Graphic PLC with optional machine functions
- Heidenhain-type absolute space measuring system (3µm)
- Nano interpolation, vector feed-forward
- HSHP path follow-up, closed-loop position control
- Acceleration according to third degree function (bell shape)
- Digital AC servo drives on EtherCAT bus

HSHP = High speed & High Precision

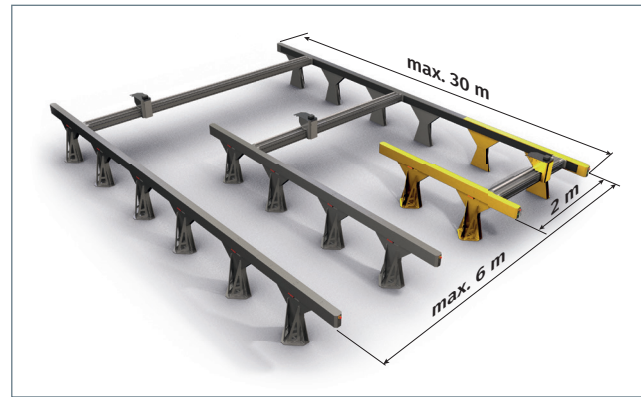

Dynamics

The balanced drives integrated into the bridge ensure the highest possible speed and acceleration. Digital AC servomotors of optimum inertia with unparalleled acceleration operate on each axis. The carriage of bridge is of compact design; fast and pitch-compensated.

Efficiency

The continuous preciseness of mass-production with minimum energy consumption, the shortest possible production lost-times and little maintenance requirements is guaranteed. It is recommended in all the fields of application where flexible, cost-effective CNC equipment with low space requirement and low purchase cost is required.

Protection, reliability

It is provided against pollution of vapor, smoke, chips, dust and other wastes by a full longitudinal cover, a cross-wise fire resistant bellow as well as a closed Z console that minimize the maintenance requirements of the mechanics. It is equipped with a central grease lubrication system with dosing as required. It is mounted with operator cabin within the work area in order to filter out the noise and production by-products. It is provided with multiple safety loop for the protection of the operator and the environment.

One-, two-, or three-dimensional waterjet cutting and robot applications

Due to the universal applicability of the waterjet cutting technology, it is used for a very wide range of cutting applications. Consequently, there is a big variety of available waterjet cutting systems:

- 1d slitter systems for cutting web material
- 2d cutting tables for cutting sheet material
- 3d robot applications for complex three-dimensional outlines
- Further customized solutions

One-dimensional cutting

One-dimensional systems are mostly used for cutting web material. The material is placed on a conveyor chain, which carries it at high speed through a portal construction. This construction is equipped with several cutting heads. The space between the cutting heads determines the width of the material stripes. As these kinds of systems are often used in multi-shift operation, high cutting speed and reliability of the production process are very important.



Two-dimensional cutting

The most frequently used system is the 2D cutting table (see picture on the next page). For cutting intricate outlines, the cutting head is guided by a central CNC control system along the x- and y-axis. Very often, the z-axis (height) is adjustable, too. That is necessary because the cutting head has to be positioned very close to the material to obtain optimal cutting results. This type of system is the ideal solution for the quick production of different workpieces from different sheet materials. A 5-axes-system enabling the cutting head to tilt via a rotation axis can realize angular and cone-shaped cuts as they are necessary for weld preparation. Also available are systems for cutting holes in pipes or tubes. The main system features include high cutting speeds and the ability to cut a large number of parts at the same time – very often, these systems are equipped with multiple cutting heads for multiplying the production output. These systems are also adapted for mirrored cuts or reverse cutting. 2D cutting tables are available in various sizes.

Robot applications for three-dimensional cutting

Especially in the automotive and mechanical engineering industry, there are complex requirements which can only be realized by a system for three-dimensional cutting.

For these kinds of applications, the cutting head is installed on a robot arm and run along a three-dimensional workpiece for trimming the material or cutting holes.

Robot systems are often equipped with rotating shuttle tables. These enable the time-saving loading and off-loading of the system while simultaneously cutting workpieces in the cutting box. Typical applications are:

Abrasive cutting

Engine components made in titanium, aluminum and stainless steel; turbine blades; marble and other decorative stone

Pure water cutting

Components for car interiors such as carpets, door panels, bumpers, dashboards, instrument panels, glove compartments, etc.

KMT – the Heart of Waterjet Cutting

For over 40 years now, our heart has been beating for waterjet cutting. You can benefit from the experience and expertise: Just let us know about your personal cutting demands. Taking your requirements into account, we will work out a cutting system concept which best fits your needs so that you can run your production efficiently and economically.



KMT Waterjet Cutting 4,000 vs. 6,000 bar

The ideal solution for every application

With a comprehensive portfolio of high pressure pumps, KMT Waterjet Systems offers the ideal technology for every requirement – from occasional cutting needs to multi-shift operation. Basically, KMT distinguishes between the Pro series for working pressures of up to 6,200 bar and the pump models STREAMLINE SL-V, JETLINE JL-I and NEOLINE NL-I which operate in a maximum pressure range of 3,800 to approx. 4,100 bar.

Unsurpassed productivity

The advantages of the high operating pressure of 6,200 bar are particularly relevant for efficiency where operators need to cut thick and/or very hard materials. The high operating pressure improves conformality as well as the quality of the cut edge compared to traditional 4,000 bar applications.

- Depending on the material and its thickness, cutting with 6,200 bar allows operators to increase the cutting speed by up to 50%. In some applications, the increase is even higher.
- Higher operating pressures improve conformity as well as the quality of the cut edge. In many cases, there is no need for reworking cut edges.
- Cutting with 6,200 bar significantly reduces the consumption of abrasive.
- Thanks to the increased cutting speed, more workpieces can be cut in the same time. This leads to lower costs per piece.
- The high working pressure when piercing and cutting the workpiece reduces the delamination for composite material.

Choosing the right pressure system

The following tables can be used to find the high pressure system that is best for a specific application. There are three main variables driving the choice:

1. Type of material

The quality and thickness of the material crucially determines the possible cutting speed and the necessary orifice size. Moreover, the material's hardness determines whether to apply pure water or abrasive cutting.

2. Cutting speed

The possible cutting speed determines the number of orifices needed to meet your production requirements. Speed per cutting head will vary based on the thickness of the material, the operating pressure, the quality and quantity of abrasive, the shape to be cut and type of edge finish desired.

3. Size and number of orifices

The water consumption of the cutting machine depends on the size and number of orifices. The more orifices are operated simultaneously and the larger these orifices are, the higher are the requirements for the pump's performance.

For personal assistance in selecting the high pressure system which is right for a specific application, call ProCAM. If you do not find your individual material in the list below, our ProCAM experts will help you to determine the relevant cutting speeds for you.

Step 1 – Determine the approximate Cutting Speed Rates required. By knowing the speed rate and estimating the orifice size range, a decision can be made on the number of cutting heads required.

Possible cutting speed (mm/min) *					
	Pressure (bar)	6200	4100	6200	4100
	Water Orifice (Ø)/Focusing Tube (mm)	0,20/0,60	0,25/0,75	0,25/0,75	0,35/1,05
	Abrasive flow (g/min)	400	500	650	750
Material	Material Thickness (mm)				
Aluminium	10	600-750	400-500	850-1100	600-850
	20	250-300	150-200	300-450	250-350
	40	80-110	50-90	120-170	80-110
Stainless Steel	10	200-250	110-160	250-350	190-250
	20	60-90	40-60	100-150	70-100
	40	25-40	15-25	35-55	25-40
Black Granite	10	550-700	350-450	750-1000	550-800
	20	200-270	130-180	300-400	200-300
	40	70-100	55-75	100-150	80-110

* Surface Quality: medium – smooth

The values in the table are only approximate values as the actual cutting speed may be influenced by further variables (water quality, orifice wear, etc.).

Step 2 – Determine the size of the machine, based on the orifice size and number of cutting heads. The KMT high pressure pumps differ according to maximum pressure range and motor power which affects the water flow rate.

Maximum no. of orifices at Maximum Pressure										
Orifices size (mm)	PRO-2 125 ¹	PRO-2 60 ¹	SL-V 200 ²	SL-V 100 ²	SL-V 50 PLUS ²	SL-V 50 CLASSIC ³	SL-V 50 OEM ³	JL-I 50 ³	NL-I 40 ³	SL-V 15 ³
0,10*	16	7	45	22	11	12	12	12	9	3
0,12*	10	5	29	14	7	8	8	8	6	2
0,17	5	3	14	7	3	4	4	4	3	1
0,20	4	1	11	5	2	3	3	3	2	-
0,23	3	1	9	4	2	2	2	2	1	-
0,25	2	1	7	3	1	2	2	2	1	-
0,28	1	-	6	3	1	1	1	1	1	-
0,30	1	-	5	2	1	1	1	1	1	-
0,35	1	-	3	1	-	1	1	1	-	-
0,40	-	-	2	1	-	-	-	-	-	-

* This orifice size is used for pure water cutting only.
1 at 6,200 bar 2 at 4,100 bar 3 at 3,800 bar

KMT – High Pressure technology

The Intensifier

The best possible reliability as well as simple and quick maintenance are the key features in the development of all KMT high pressure pumps.

The simple modular design enables the replacement of every single wear part. This design principle ensures that each component can be used to its maximum lifetime.

Built-in safeguards

High-tech software and built-in sensors provide protection and immediate access to information. More control and information is available faster.

Long-term competitiveness

We are continually adding new technology to our pumps and making it available as retrofit kits for older pumps. Buy a KMT pump today and be assured that you will have access to the most efficient and latest technology long into the future.

THE INTENSIFIER – the reliable heart of all Ultra-high pressure pumps

The source of the power in high pressure systems is found in the intensifier. KMT has modified that source to set new standards in terms of user friendliness, maintenance requirements and overall reliability.

Plunger

The plunger consists of a ceramic material; compared to a metal plunger, the harder and smoother surface resists better against wear, eliminates scoring and increases seal lifetimes.

Exclusive long, slow stroke

Reduced maintenance at extended seal life are a result of the longer (8") stroke generating less stress reversals than alternative products.

HYPERLIFE™ seal kit

Patented high pressure seal design ensures optimized lifetime.

Weep hole indicators

Weep holes reveal the condition of internal seals to protect all high pressure components from major damage due to wear and to achieve maximum lifetimes of the components.

“One-Step” seal and valve replacement

Low and high pressure valves installed in the check valve body can be replaced in one step within a period of 5–10 minutes only.

Hydraulic seal

The convenient, cartridge-style seal in the intensifier combines 6 seals on one cartridge; it can be changed quickly without the need to disassemble the entire hydraulic section of the intensifier.

Electronic shifting

Electronics provide reliable signals for smoother shifting to contribute to a stable pressure signal, which is needed to achieve best cutting edge quality.

Soft Seal End Cap design „SSEC“

Several thousand intensifiers of the SSEC type are currently in use all over the world, many of them in multiple shift operations. A tried and tested seal assembly ensures a reliable sealing and preloaded jack bolts in the end cap of the intensifier, which can be loosened and tightened without special tools, guarantee simple maintenance. The models JETLINE and NEOLINE are equipped with such an intensifier.

Hard Seal End Cap design „HSEC“

The innovative end cap design provides a metal- to-metal seal which eliminates rubber seals thus reducing consumables and saving operating costs while simultaneously increasing the uptime of your cutting system. The HSEC Design is used in all pumps of the STREAMLINE series. It further includes a larger version (intensification ratio 23:1) for high pressure pumps with 100 HP and more as well as a smaller version (intensification ratio 20:1) for 50 HP pumps.

Bolted end cap for the cylinder

The sophisticated design of the end cap enables the more than 4,000 bar (6,000 bar) to be restrained by a torque of only 48 Nm (96 Nm). Furthermore, it is not necessary to completely dismantle the intensifier for maintenance works.

“Quick release” plunger concept

Thanks to patented design, the removal of the ceramic plunger from the hydraulic piston needs just 4 steps without the necessity to disassemble the entire hydraulic section.

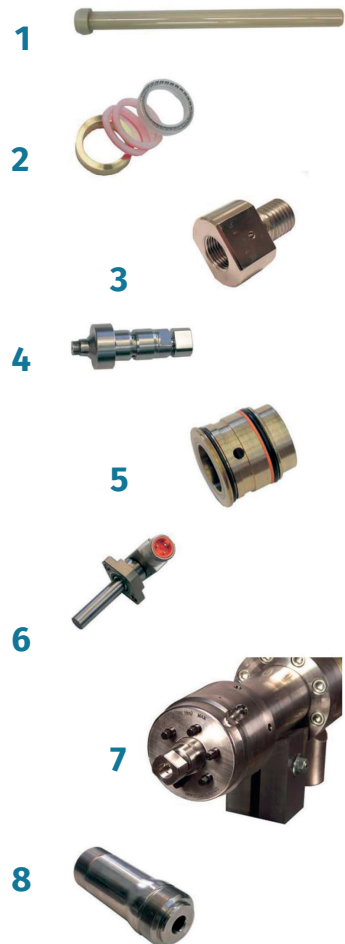
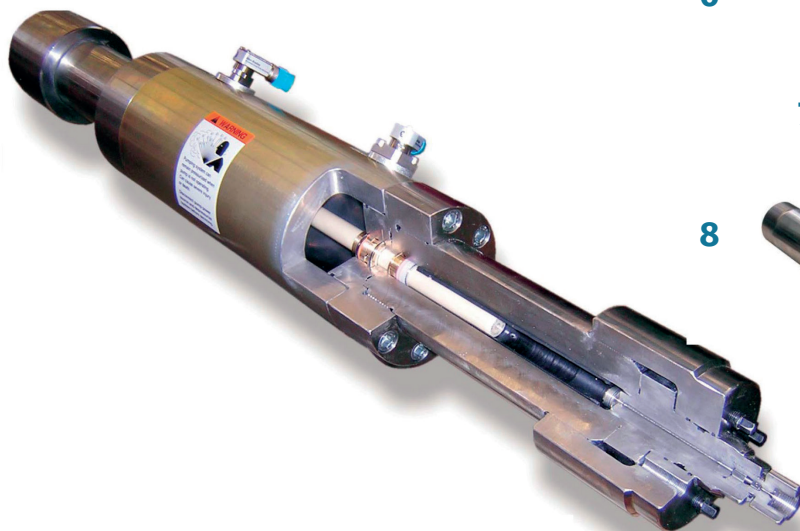

Description	Unit	PRO-2 125	PRO-2 60	SL-V 200 PLUS	SL-V 100 PLUS
Motor Rating	kw/hp	93/125	45/60	149/200	74/100
Pressure Range	bar	800-6200	800-6200	500-4136	500-4136
Max. Flow Rate at max. Pressure	l/min	5,8	2,7	14,0	7,0
Length	mm	2238	1980	2305	1975
With	mm	1500	914	1695	914
Height	mm	1552	1453	1778	1453
Weight	kg	3107	1650	4000	1905
Cutting Water Circuit					
Intensifier Design		Rapid Change	Rapid Change	HSEC 23	HSEC 23
Intensifier System		Dual	Single	Dual	Single
Plunger Material		Ceramics	Ceramics	Ceramics	Ceramics
Intensification Ratio		38,5:1	38,5:1	23:1	23:1
Max. Stroke Rate	1/min	2x42	42	2x71	71
Attenuator Volume	l	1,6	1,6	3	3
Cutting Water Inlet Pressure	bar	2-4	2-4	2-4	2-4
Min. Cutting Water Inlet Flow	l/min	34,8	15	60,6	30
Low Pressure Filter	µm abs.	10	10	10	10
High Pressure Transducer		●	●	●	●
Controls & Electric					
Control System		Eaton Moeller	Eaton Moeller	Eaton Moeller	Eaton Moeller
User Control Display		5,7" Color Touchscreen	5,7" Color Touchscreen	5,7" Color Touchscreen	5,7" Color Touchscreen
No. of Display Languages		11 ¹	11 ¹	11 ¹	11 ¹
Motor Start		Softstarter	Softstarter	Softstarter	Softstarter
Nom. Current at 400/50Hz	A	160	81	275	124
Fuse Size at 400/50Hz	A	200	100	275	160
Pneumatic, Hydraulics & Cooling Circuit *					
Quick Change Plunger		●	●	●	●
Hdraulic Tank Capacity	l	416	182	473	182
Standard Features & Options					
Oil Level and Temperature Control		Sensor	Sensor	Sensor	Sensor
Redundant Intensifier		-	○	○	○
Dual Pressure Settings		-	-	-	●
Proportional Control		●	●	●	○
Cutting Water Inlet Shut-Off Valve		●	●	●	●
Safety Dump Valve		●	●	●	●
Adjustable Booster Pump		●	●	●	●
Oil/Water Heat Exchanger		●	●	●	●
Oil/Air Cooler		○	○	○	○
Oil Drip Pan		●	●	●	●
Others					
Label Acc. to EC-Mach. Directive		CE mark	CE mark	CE mark	CE mark
Max. Sound Level	db(A)	<83,8	<76,6	<84,5	<78,2
Max. Number of Orifices at max. Pressure					
0,10***		16	7	45	22
0,12***		10	5	29	14
0,15***		7	4	20	10
0,17		5	3	14	7
0,20		4	1	11	5
0,23		3	1	9	4
0,25		2	1	7	3
0,30		1	-	6	3
0,33		1	-	5	2
0,38		1	-	3	1
0,40		-	-	2	1
0,43/0,45/0,48/0,70		-	-	2/2/2/1	1/1/0/0

¹ English, German, Finnish, French, Italian, Polish, Russian, Spanish, Swedish, Czech, Chinese

² English, German, Finnish, French, Italian, Polish, Spanish, Swedish, Czech ³ English, Chinese ⁴ English

SL-V 50 PLUS	SL-V 50 CLASSIC	SL-V 50 OEM	JL-I 50	NL-I 40 OEM	SL-V 15 STD
37/50	37/50	37/50	37/50	39/40	11-15
500-4136	500-3800	500-3800	500-3800	500-3800	500-3800
3,5	3,8	3,8	3,8	2,8	1,2
1727	1869	2168	2006	1436	1422
914	914	1000	914	1167	711
1453	1222	1094	1183	1005	833
1234	1179	995	1111	975	735
Cutting Water Circuit					
HSEC 23	HSEC 23	HSEC 23	SSEC-PL	SSEC-PL	SSEC-20
Single	Single	Single	Single	Single	Single
Ceramics	Carbide	Ceramics	Carbide	Carbide	Ceramics
20:1	20:1	20:1	20:1	20:1	20:1
48	54	54	54	39	17
2	1	1	1	1	0,5
2-4	2-4	2-4	2-4	2-4	2-4
15,1	15,1	15,1	15,1	11,4	5,7
10	10	10	10	10	10
○	○	○	○	○	-
Controls & Electric					
Eaton Moeller	Eaton Moeller	Eaton Moeller ○	Siemens	Eaton Moeller ○	Relay
5,7" Color Touchscreen	3,5" Touchscreen b&w	3,5" Touchscreen b&w	4 line Display b&w	4line Display b&w ○	-
11 ¹	9 ²	9 ²	2 ³	1 ⁴ ○	-
Softstarter	Softstarter	Softstarter ○	Y / D Starter	Softstarter ○	Y / D Starter
66	66	66	66	52	22
80	80	80	80	63	25
Pneumatic, Hydraulics & Cooling Circuit *					
●	●	●	-	●	●
151	144	151	151	144	53
Standard Features & Options					
Sensor	Sensor	Sensor	Switch	Switch	Sensor
○	-	-	-	-	-
●	●	●	●	●	-
○	○	○	○	-	-
●	●	●	●	●	●
●	●	○	●	●	●
●	●	●	●	●	-
●	●	●	●	●	●
○	○	○	○	○	○
●	●	○	●	●	●
Others					
CE mark	CE mark	Declaration of incorp.	-	Declaration of incorp.	CE mark
<76,2	<80	n/a	n/a	<78	<75,5
Max. Number of Orifices at max. Pressure					
11	12	12	12	9	3
7	8	8	8	6	2
5	5	5	5	4	1
3	4	4	4	3	1
2	3	3	3	2	-
2	2	2	2	1	-
1	2	2	2	1	-
1	1	1	1	1	-
1	1	1	1	-	-
-	1	1	1	-	-
-	-	-	-	-	-
-	-	-	-	-	-

* The following applies to all pumps:

Min. pneumatic air pressure 5.9 bar

Max. pneumatic air flow rate 28.3 l/min

Ambient temperature at Oil-to-Air cooling circuit 5 - 30 °C

** Full version with CE mark

*** This orifice size is used for pure water cutting only.

● Standard ○ Option Ambient temperature at Oil-to-Water cooling circuit 5 - 40 °C

Complete waterjet cutting equipment

PreciTrack® PTW2030

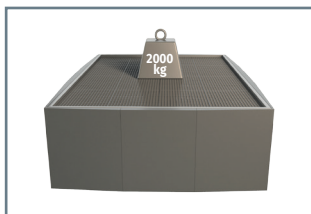
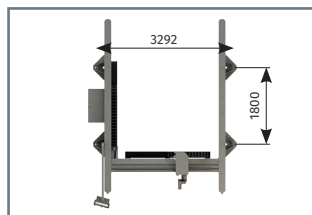
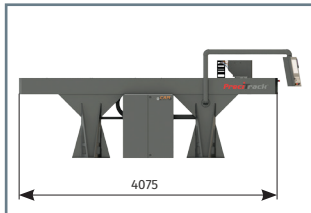
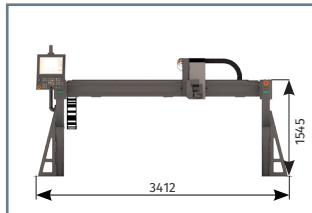

PreciTrack PTW2030 technical specifications

X Y Z Axis	3418x3850x1700 mm
Work area (x, y, z)	2000x3000 mm
Weight	~ 2000 Kg
Load capacity	~ 2000 kg
Power	~ 35 kW
Drive	Digital AC servo
Rapid traverse speed X	60 mm
Rapid traverse speed Y	60 mm
Rapid traverse speed Z	30 mm
Maximal step precision	0,01 mm
Operational step precision	0,05 mm
Retrack precision	0,05 mm
Cutting technology	KMT NeoLine NL-I 40 waterjet
No. of heads	1 pc.
Pressure range bar/psi	500-3.800 bar
Cutting fluid flow (max)	2,7 /min
Coolant flow (max)	9,5 l/min (24C°)
Max. noise level dB(A)	80 dB
Control	NCT 201

We designed the complete unit above according to the industrial averages so it is an applicable solution for most manufacturers but if you have other production demands you can naturally order a different configuration, as well. Due to the PreciTrack coordinate track the size, technology and accessory units can be changed in a flexible way.

High-Pressure Pumps – 6,200 bar

STREAMLINE™ Pro-2 60/125

With its PRO high-pressure range, KMT Waterjet Systems sets new standards in the field of water-jet cutting. Pro stands for waterjet cutting technology with operating pressures of up to 6,200 bar, and the new range of products of course includes all necessary components and accessories - from high-pressure generation units to orifices that guide the cutting jet with great precision onto the material.

- STREAMLINE PRO Ultra high-pressure pumps
- ACTIVE AUTOLINE PRO abrasive cutting head
- ACTIVE IDE PRO abrasive cutting head
- AQUALINE PRO pure water cutting head
- AMS PRO abrasive management system
- PSC PRO valves, pipes and fittings

Taking into account the increased exposure to high pressure, the PRO products were designed to ensure economical operation with enhanced service life. The original PRO series by KMT Waterjet thus offers you optimized high-pressure equipment meeting the highest requirements as regards reliability and cutting quality in heavy-duty continuous operation.

Advantages of Waterjet Cutting at 6,200 bar

Compared to conventional waterjet cutting at 4,100 bar, the increased maximum pressure range features the following benefits:

- Higher cutting speeds
- Improved cutting edge quality
- Lower abrasive consumption
- Higher productivity
- Optimized machine utilization
- Improved conformality
- Reduced delamination

Ultra-high pressure pump STREAMLINE Pro

The high pressure pumps of the STREAMLINE™ PRO series have significantly enhanced the productivity and efficiency of the waterjet cutting technology. The innovative high pressure pumps have been designed for both pure water and abrasive waterjet cutting at operating pressures of up to 6,200 bar.

The STREAMLINE PRO is available in two models with 45 kW or 93 kW. At a pressure of 6,200 bar, the two machine versions offer volumetric flows of 2.7 l/min and 5.8 l/min respectively. This enables the operator to cut with either single or multiple heads.

Two pressure intensifiers for an optimized pressure signal

In the PRO 125 with 93 kW, the cutting pressure of 6,200 bar is produced with the help of two pressure intensifiers, which are operated with a phase shift. These intensifiers pump the cutting water through a 1.6 l pressure accumulator to the cutting heads. The standard model comes with a proportional pressure control system for the stepless adjustment of the cutting pressure. It is also equipped with a pressure transducer monitoring the cutting pressure in the high pressure line. This control circuit ensures equal utilization of the two pressure intensifiers and optimizes the pressure signal, which significantly affects the cut edge quality of the workpiece.

With the introduction of the 6,200 bar Pro technology, KMT Waterjet Systems set new standards in the field of waterjet cutting. With the launch of the next generation of this advanced technology, the STREAMLINE Pro-2 UHP pump, KMT offers the industry's most powerful combination of horsepower and pressure with significant advances in uptime.

High efficiency thanks to reduced maintenance
 Due to the unique and simple design of the new Rapid Change INTENSIFIERSM and more durable components, the STREAMLINE PRO-2 intensifier requires substantially less time for replacement of parts than conventional waterjet pumps. As a result, preventive maintenance is kept to a minimum.

The STREAMLINE PRO-2 state-of-the-art intensifier quick seal change process means more uptime as seals can be replaced within 20 minutes only.

Reduced maintenance is also attributed to the longer reciprocal stroke rate to move more volume of water, which also extends the life of the seals. This improved reliability and flexible ergonomic design combine to provide extremely efficient cost savings and improved productivity.

What makes the maintenance even simpler is the fact that the STREAMLINE PRO-2 Rapid Change INTENSIFIERSM features only a comparably small amount of parts and components and that the necessity for specialty tools when changing seals is reduced considerably.

Benefits of KMT's rapid Change UHP INTENSIFIERSM

- Maintenance friendly design = more uptime
- Reduces seal change time by 50% vs. conventional UHP pumps
- Low torque hard seal end cap design
- Eliminates complicated bolt tensioning and tie rods
- Reduces specialty tools required
- Longer lifetimes of seals and consumable parts
- Improved cylinder alignment
- Fewer component parts

	PRO-2 125 ¹	PRO-2 60 ²			
Motor Rating	93kw/125hp	45kW/60hp			
Pressure Range	800-6200 bar				
Max. Flow Rate at max. Pressure	5,8 l/min	2,7 l/min			
Intensifier Design	Rapid Change				
Label acc. to EC-Mach. Directive	CE mark				
Max. Number of Orifices at max. Pressure					
Orifice Sizes Pure Water Cutting			Orifice Sizes Abrasive Cutting		
0,10	0,12	0,15	0,17	0,25	0,35
¹ 16	10	7	5	2	1
² 7	5	4	3	1	-



ACTIVE AUTOLINE™ PRO + ACTIVE IDE™ PRO

The Pro abrasive cutting heads from KMT WATERJET SYSTEMS have been specially designed for waterjet cutting with 6,200 bar. Their design and materials can withstand huge forces while focusing the energy to the point where it is needed, namely to the cutting jet.

ACTIVE AUTOLINE™ Pro Abrasive cutting head

Among the outstanding features of ACTIVE AUTOLINE™ PRO cutting heads are automatic precision positioning, perfect repetition accuracy, high cutting speeds, long service life and easy maintenance. It takes only seconds to replace the few wear parts of the head, such as the orifice, mixing chamber and focusing tube, and no tools are required. In order to keep routine maintenance to a minimum, these parts are made from tough wear-proof materials. The typical features of KMT products based on the innovative approach for efficiency and economy in continuous operation have thus been successfully integrated into the design of the cutting head.

ACTIVE AUTOLINE™ PRO cutting heads can be integrated into all waterjet cutting systems with rigid or multiple head connections.

ACTIVE IDE™ Pro Improved cutting performance thanks to high precision

The ACTIVE IDE™ PRO cutting head features a diamond orifice which is firmly integrated into the orifice body. A specially devised manufacturing method ensures that the waterjet is properly aligned at all times and connected to the mixing chamber located below the orifice body. In the mixing chamber, the abrasive is added to the waterjet. The stringent produc-



tion tolerances for the mounted cutting head guarantee that the cutting jet is always properly aligned along the axis. As the waterjet exits the focusing tube at the correct angle, the power of the waterjet is focused for optimum impact. This allows for maximum cutting speeds at minimum cutting gaps combined with excellent cutting edge quality.

HYPERTUBE Pro focusing tube for 6,200 bar applications

With the HYPERTUBE PRO, KMT Waterjet has developed a patented design that considerably prolongs the service life of the

focusing tube. In most cases, the focusing tube shows asymmetric wear, which results in an elliptic deformation of the outlet opening. HYPERTUBE PRO focusing tubes are equipped with an index that enables operators to repeatedly turn the tube by a set angle in the housing of the cutting head. This results in a uniform wear pattern so that the waterjet cross-section remains circular.

The jet remains properly focused for a longer period of time, which further helps reduce the operating costs of the waterjet cutting unit. Experience shows that this patented solution prolongs the service life of focusing tubes by around 100%.

Pure Water Cutting Head – 6,200 bar

AQUALINE PRO

The nozzle valve for maximum stress

The wide range of cutting tasks and numerous switching cycles puts a heavy strain on the nozzle valve. With the AQUALINE PRO pure water cutting head, KMT has developed the perfect solution for 6,200 bar applications. As the cutting speed is higher than with 4,000 bar, delamination is significantly reduced and in many cases completely eliminated. Depending on the actual requirements, the valves are available as normally open (N/O) or usually closed (N/C) valves. These high-pressure valves usually open in less than 50 ms, depending on the operating pressure. High precision, sturdy design and extremely short switching times are the key features of the AQUALINE PRO waterjet cutting head range.

PSC-PRO 6,200 bar valves, connectors and pipes

PSC stands for Precision System Components, which include all installation parts required in high pressure cutting technology to feed the cutting water from the pump to the connected cutting stations. The PRO series of PSCs has been specially developed to meet the requirements of waterjet cutting with 6,200 bar. The comprehensive PSC-PRO range of products allows for the flexible and reliable installation of pipeline systems suitable for all commonly used cutting systems. PSCs from KMT offer unrivalled reliability, availability and wear-resistance.



High-Pressure Pump – 4,136 bar

STREAMLINE™ SL-V 200 Plus

The model STREAMLINE SL-V 200 Plus by KMT WATERJET SYSTEMS is an advanced pump for large demanding high pressure waterjet applications. The high volume intensifiers are designed for ease-of-use, simple maintenance and low total costs.

High pressure water reliability

Some KMT high pressure pumps have the option to install an additional intensifier as stand-by. This means that there is a spare capacity in the volumetric flow providing extra dependability for demanding production schedules.

Minimal floor space required

One 200 horsepower pump requires much less floor space than four 50 horsepower pumps. Moreover, the installation of just one single pump leads to reduced efforts in terms of installation material and external balancing equipment thus saving additional space.

Customer-focused design

The intensifiers are located in the front of the machine for easy access during physical inspections and maintenance. Removable swinging front doors additionally facilitate the maintenance procedures.



Reduced total costs

The costs of one pump (both operating cost and investment cost) are lower than those of several smaller pumps, and the minimized number of wear parts of just one pump further results in lower operating costs.

Intensifier capacity modes

- Partial Operation Mode
In order to keep the production running even if one intensifier needs maintenance, the pump can run with one intensifier only. This feature provides 50 % uptime.
- Reserve Mode (Option)
Add an optional third intensifier as a backup source of pressure. The third intensifier can be used when one (or two) of the others needs to be taken offline for maintenance. Each intensifier can use up to 100 hp.

		SL-V 200 Plus			
Motor Rating		142kw/200hp			
Pressure Range		500-4136 bar			
Max. Flow Rate at max. Pressure		14 l/min			
Intensifier Design		HSEC 23			
Label acc. to EC-Mach. Directive		CE mark			
Max. Number of Orifices at max. Pressure					
Orifice Sizes Pure Water Cutting			Orifice Sizes Abrasive Cutting		
0,10	0,12	0,15	0,17	0,25	0,35
45	29	20	14	7	3

High-Pressure Pump – 4,136 bar

STREAMLINE™ SL-V 50 / 100 Plus

The STREAMLINE™ SL-V pumps enable you to use the generated pressure for both pure water and abrasive applications. Regardless of how your machine concept is designed: the STREAMLINE™ SL-V pumps can be installed and operated either independently or they can be controlled remotely through any kind of central control system.

Designed for multiple shift operation

Day by day, hundreds of our STREAMLINE™ pumps do their job, often up to 3 shifts per day. In particular, automotive end-users honor their outstanding high reliability level.

Working pressure of up to 4,136 bar

The pump units are available in two different power rates (37 and 74 kW). Wherever required, the STREAMLINE™ SL-V supplies high pressure water of up to 4.136 bar. In those areas where such a high pressure is not needed, the STREAMLINE™ SL-V can cut material at a lower pressure.

Single intensifier concept on all pump sizes

Up to 4,136 bar is produced with just one intensifier in all pump sizes, delivering lower maintenance costs and quieter operation with fewer parts. The longer, slower strokes of the ceramic plunger move more water with each stroke to provide increased lifetimes through reduced seal wear.

Booster pump protection

Sensors in front of and behind the booster pump assure that the flow of water is continual and adequate. This is an important feature to protect components particularly in the high pressure section.

Softstarter as standard saves electricity costs

The included softstarter additionally helps you to decrease your operating cost by reducing peaks in the consumption of electricity. Your local current supply usually does not have to get modified to install the STREAMLINE™ SL-V unit.

MOELLER touch Screen Control with multi-language display

The Moeller touch screen control system provides you with all comfort you can expect from a control system. You can select up to 11 different display languages. You have access to individual alarm histories to achieve best components lifetimes and you get guided very accurately through any maintenance related topic.



	SL-V 100 ¹	SL-V 50 ²				
Motor Rating	74kW/100hp	37kW/50hp				
Pressure Range	500-4136 bar					
Max. Flow Rate at max. Pressure	7 l/min	3,5 l/min				
Intensifier Design	HSEC 23	HSEC 20				
Label acc. to EC-Mach. Directive	CE mark					
Max. Number of Orifices at max. Pressure						
Orifice Sizes Pure Water Cutting		Orifice Sizes Abrasive Cutting				
	0,10	0,12	0,15	0,17	0,25	0,35
¹	22	14	10	7	3	1
²	11	7	5	4	2	1

High-Pressure Pumps – 3,800 bar

STREAMLINE™ SL-V 50 Classic

Our STREAMLINE™ SL-V Classic reflects the market requirement for a completely self-contained, easy to hook up unit, guaranteeing you top HSEC intensifier technology in an affordable package. You can use this pump both ways: either independently as a stand-alone unit or communicating with the central control system of the entire cutting machine.

Applicable for pure water & abrasive cutting

The STREAMLINE™ SL-V Classic is designed for flexible production in pure water as well as in abrasive applications. It is dedicated to those kinds of cutting jobs which require cutting pressure of up to 3,800 bar. The high reliability and lifetime performance equal those of our more sophisticated “Plus” series.

Softstarter as standard saves electricity costs

The included softstarter additionally helps you decrease your operating cost by reducing the startup current needed for the motor. This means savings not only in your monthly electricity bill; also expensive modifications to your power supply are no longer necessary with all the STREAMLINE™ SL-V Pumps, including the Classic.



Innovative concept reduces service costs

The STREAMLINE™ SL-V Classic pump has less wear parts than conventional pumps. There is only one single long-life seal assembly necessary for each high pressure cylinder.

MOELLER display in 9 languages

The Moeller control system provides you with all the classic features which are needed to run the pump and to reliably and economically operate your machine. You have the opportunity to select up to nine different display languages.

		SL-V 50 Classic					
Motor Rating	37kw/50hp						
Pressure Range	500-3800 bar						
Max. Flow Rate at max. Pressure	3,8 l/min						
Intensifier Design	HSEC 20						
Label acc. to EC-Mach. Directive	CE mark						
Max. Number of Orifices at max. Pressure							
Orifice Sizes Pure Water Cutting			Orifice Sizes Abrasive Cutting				
0,10	0,12	0,15	0,17	0,25	0,35		
12	8	5	3	1	0		

High-Pressure Pump – 3,800 bar

STREAMLINE™ SL-V 15 STD

The STREAMLINE™ SL-V 15 pump was specifically designed for light-duty applications demanding a reliable source of high pressure. It is dedicated to cutting systems using one to three cutting heads to cut soft materials with a pure waterjet such as food, textiles, paper, foam, gypsum cardboard or insulation material.

Compact Design for Convenient Integration

The compact design of the STREAMLINE™ SL-V 15 pump supports the machine manufacturer to integrate the pump in his individual systems design communicating with the control system of the entire machine. On the other hand, it can also be installed as a stand-alone unit. It does not require much space and all components are very easy to access for maintenance. For better visibility and ease of maintenance, it provides an open view to the high pressure generating intensifier.

Safety functions and features

The safety dump valve kit releases the pressure from the system as soon as the pump shuts off by pressing the emergency stop. It shuts off automatically if the oil level is below the minimum level or if the oil overheats. In these cases, a red light flashes in order to indicate the faulty operating condition to the operator.

Abrasive cutting also possible

The SL-V 15 pump also has the capability to supply one abrasive cutting head for cutting harder materials of smaller thickness. It allows operating the lowest orifice combination needed for abrasive cutting. If you intend to use your system mainly for abrasive applications and if the thickness of the materials varies case by case, you should consider the installation of a more powerful KMT pump.

		SL-V 15 STD			
Motor Rating		11kw/15hp			
Pressure Range		500-3800 bar			
Max. Flow Rate at max. Pressure		1,2 l/min			
Intensifier Design		HSEC 20			
Label acc. to EC-Mach. Directive		CE mark			
Max. Number of Orifices at max. Pressure					
Orifice Sizes Pure Water Cutting			Orifice Sizes Abrasive Cutting		
0,10	0,12	0,15	0,17	0,25	0,35
3	2	1	1	-	-



High-Pressure Pumps – 3,800 bar

JETLINE™ JL-I 50

The JETLINE™ high pressure pump is equipped with an SSEC intensifier and combines all the advantages of KMT Waterjet Systems for waterjet cutting applications. As the pump has been especially designed for the Asian market, it is not CE marked. Nevertheless, it meets all expectations regarding cost-efficient waterjet cutting.

Economic waterjet cutting in one-shift operation

The high pressure pump JETLINE JL-I is available with 37 kW and can serve waterjet cutting machines operating with single or multiple cutting heads. Due to the intellyest control system and the intensifier design, the JETLINE pump is best used in one-shift operation.

Built-in safety thanks to intellyest control system

To ensure highest safety and reliability, the JETLINE™ is equipped with a PLC system including a text display. This four-line display provides the machine operator with valuable information regarding the operating status of the pump. Information that might be relevant for proper servicing is thus easily available, and the display acts as an indispensable tool for troubleshooting.

Suitable for stand-alone operation or integration into overall system

Depending on the customer's requirements, the pump can be run as a stand-alone unit or integrated into the control system of the overall plant. The messages of the four-line display can be transferred to the control desk display of the plant control system.

Energy-efficient motor start

To prevent voltage peaks that affect the energy costs, each JETLINE™ pump is equipped with a Wye-Delta starter unit. Your power system is thus not subjected to unnecessarily high loads.



JETLINE JL-I 50					
Motor Rating	37kw/50hp				
Pressure Range	500-3800 bar				
Max. Flow Rate at max. Pressure	3,8 l/min				
Intensifier Design	SSEC-PL				
Label acc. to EC-Mach. Directive	-				
Max. Number of Orifices at max. Pressure					
Orifice Sizes Pure Water Cutting			Orifice Sizes Abrasive Cutting		
0,10	0,12	0,15	0,17	0,25	0,35
12	8	5	4	2	1

High-Pressure Pump – 3,800 bar

NEOLINE™ NL-I 40 OEM

The NEOLINE™ NL-I 40 High Pressure Pump features KMT's proven and reliable SSEC intensifier technology in an affordable entry-level product, thus offering a great value at a reasonable price. It is the perfect solution for everyone who is looking for an economical waterjet cutting solution for occasional cutting needs using the best technology the industry has to offer.

Tried and tested concept helps reduce operating costs

As the intensifier contains only a small number of wear parts, operating costs are kept low in comparison with conventional pumps. Also contributing to the outstanding economy of the pump is the long service life of the components subject to wear. Costly downtimes are thus virtually eliminated.

Fit-to-need electric controls

The full version of the NEOLINE™ pump uses basic PLC based controls for pump on/off and E-Stop with a user-friendly operator interface including an electrical junction box. However, for system manufacturers who want to control the pump by their turnkey system-PLC it is also available without any pre-installed electric controls.

Elaborate design for ease of operation and a long product life

The NEOLINE™ pump has been developed with the aim of creating a robust, easy to operate pump. It is driven by a 40 hp (29 kW) three-phase motor which is equipped with vibration isolation pads to protect the rest of the pump from the motor activity. Furthermore, the NL-I 40 features a rugged powder-coated finish protecting the surface from environmental influences. For ease of operation, the KMT engineers developed a new low profile cabinet design which grants easy access to the pump controls and other components.

Further features of the NEOLINE™ NL-I 40 (full version) include

- Dual Pressure Compensator
- Manual Pressure Control
- Auto Bleed Down Valve
- Booster Pump with 10 micron Filter
- Low Inlet Water Pressure Safety Switch (2 bar)
- Variable Displacement Axial Piston Pump
- Y / D Starter
- CE-marked

NEOLINE NL-I 40 OEM					
Motor Rating	29kw/40hp				
Pressure Range	500-3800 bar				
Max. Flow Rate at max. Pressure	2,7 l/min				
Intensifier Design	SSEC-PL				
Label acc. to EC-Mach. Directive	Declaration of Incorporation				
Max. Number of Orifices at max. Pressure					
Orifice Sizes Pure Water Cutting			Orifice Sizes Abrasive Cutting		
0,10	0,12	0,15	0,17	0,25	0,35
9	6	4	3	1	-



High-Pressure Pump – 3,800 bar

STREAMLINE™ SL-V 50 OEM

KMT WATERJET SYSTEMS offers an intensifier manufactured for complete system integration. The SL-V 50 OEM intensifiers are designed for those users who prefer to design and build the pump control logic themselves, including shutdown due to overstroking, overheating, loss of water pressure and all other aspects of pump control. The SL-V 50 OEM is specifically designed for application operations requiring more powerful cutting.

Compact size fits any machine

The proven KMT technology can be easily implemented into the individual machine design of every manufacturer of waterjet cutting machines: Its compact size allows the customer to install the pump at the intended place in the machine frame. All components which require frequent maintenance are accessible very easily.

Junction box

The intensifier's electrical control panel, motor controls and PLC are replaced with an interface wiring junction box, allowing the system builder to supply all power, control and logic interface to the intensifier from the motion control panel. The entire waterjet cutting system can then be operated and controlled from one convenient location.

Options

The pump is designed for experienced waterjet machine manufacturers with the necessary high pressure technology implementation skills and the ability to add all control and safety features. Optional kits are available to be installed by the manufacturer.

		SL-V 50 OEM			
Motor Rating		37kw/50hp			
Pressure Range		500-3800 bar			
Max. Flow Rate at max. Pressure		3,8 l/min			
Intensifier Design		HSEC 20			
Label acc. to EC-Mach. Directive		Declaration of Incorporation			
Max. Number of Orifices at max. Pressure					
Orifice Sizes Pure Water Cutting			Orifice Sizes Abrasive Cutting		
0,10	0,12	0,15	0,17	0,25	0,35
12	8	5	4	2	1

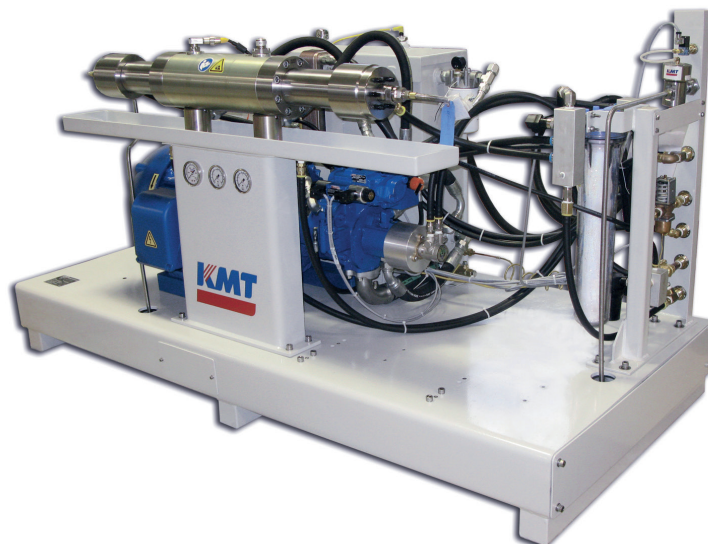

Pure Water Cutting Head – 4,136 bar

AQUALINE I

Especially automotive applications are among the most demanding of subcontracting jobs in the industry. Demands put on waterjet components are certainly not an exception, but a confirmation of this rule. Production units usually run 3x8-hour shifts throughout the complete week highlighting a need for extremely high reliability and speed.

Reliability under extreme conditions

Our AQUALINE I pure water cutting head has gained an industry-wide reputation for being amongst the quickest and the most reliable pure water cutting heads under extreme working conditions, through fastest reaction times and high component lifetimes and quality.

High performance nozzle valve

The multiple cutting cycles found in these industries place huge requirements on the on/off cycle speed and reliability of the cutting valve. The KMT AQUALINE I provides the industry's top quality leading solution in this area. Depending on the application, normally closed (N/C) and normally open (N/O) cutting valves are available. The nozzle valve opens in less than 50 ms depending on the operating pressure.

Compact design for flexible use

The AQUALINE I head weighs only 1.8 kg (3.9 lbs) guaranteeing high flexibility and making multi-head and 3-D applications easy. It can be equipped with both sapphire and diamond orifices, whatever fits the individual process needs best.

Pre-filter protects the water nozzle

The pre-filter is installed between the HD line and the nozzle valve body in the adapter. This component reduces the mechanical impact on the water nozzle, as particles are removed from the cutting jet so that they do not cause abrasion to the nozzle. This significantly prolongs the service life of the nozzle and lowers the operating costs.

AQUALINE I	
Lenght	91 mm
With	91 mm
Height (with 8" nozzle tube)	448 mm
Weight	1,8 kg
HP connection	3/8" UNF
Mounting Screws (2x)	1/4" x 7/8"
Cycle Times at 3450 bar	
N/C Valve open	< 50 ms
N/C Valve close	< 160 ms
N/O Valve open	< 50 ms
N/O Valve close	< 115 ms

Cutting speed		
Material	Thickness (mm)	Cutting speed (mm/min)
Rubber	2	27 000
	10	11 500
	20	2 200
Synthetic materials	2	22 500
	5	8 900
	10	3 400
Foamed materials	10	27 500
	100	5 500

at 4136 bar; orifice size: 0,10-0,25 mm
surface quality: medium - smooth

ACTIVE AUTOLINE™ II + ACTIVE IDE™ II

With the cutting heads ACTIVE AUTOLINE II and ACTIVE IDE II, KMT WATERJET SYSTEMS has developed abrasive cutting head assemblies that provide the best efficiency by utilizing long life components. Thus, maintenance efforts can be reduced and running times extended. The KMT cutting heads feature the following characteristics:

Design ensures correct alignment of the jet

There is no need to adjust the water jet alignment at the nozzle. The construction design ensures that the water-abrasive mixture is ejected at the center of the nozzle and at maximum speed.

Instant indication of preventable faults

The cutting head is equipped with a leakage bore near the water nozzle. It indicates whether the nozzle is installed correctly and the cutting head is properly secured. Damage to the sealing surfaces of diamond or sapphire nozzles or to the nozzle pipe can thus be easily detected and eliminated.

Pre-filter protects the water nozzle

The pre-filter is installed between the HD line and the nozzle valve body in the adapter. This component reduces the mechanical impact on the water nozzle, as particles are removed from the cutting jet so that they do not cause abrasion to the nozzle. This significantly prolongs the service life of the nozzle and lowers the operating costs.

Superior edge quality

Thanks to the longer service life of the diamond orifices, a more consistent waterjet can be achieved over a longer period of time. This in turn helps increase the lifespan of the focusing tube and results in smoother cutting edges and less waste.

Reduced setup time

The pre-aligned orifice and focusing tube reduce the operator setup time by maintaining an accurate Tool Center Point (TCP), and ensuring an effective cutting stream.

ACTIVE AUTOLINE II + ACTIVE IDE II Standard Nozzle Configuration [mm (inch)]	
0,17 (0,007)	0,54 (0,021)
0,23 (0,009)	0,76 (0,030)
0,25 (0,010)	0,76 (0,030)
0,30 (0,012)	0,90 (0,035)
0,33 (0,013)	1,10 (0,043)
0,35 (0,014)	1,10 (0,043)

ABRASIVE MANAGEMENT SYSTEM

The abrasive cutting heads ACTIVE AUTOLINE™ PRO and ACTIVE IDE™ PRO are also available in the attractive AMS package, which additionally includes the components ABRALINE and FEEDLINE thus representing the simple complete solution for the abrasive feed.



ACTIVE AUTOLINE II – Easy solution for top level performance

- The patented tool-free attachment allows for the quick exchange of the water and focusing nozzles without the need to dismantle the abrasive feed hose.
- The unique non-metallically welded nozzle base caters for high precision and repetition accuracy.
- The AUTOLINE™ II cutting head includes only three wear parts, namely the orifice, the mixing chamber and the focusing tube, which are made from extremely wear resistant materials.
- The nozzle body consists of an exchangeable insert. If worn, simply replace the mixing chamber.
- Pure-water cuts can be made with the same orifice, so retooling takes only a few seconds.

ACTIVE IDE II – Breakthrough in performance and simplicity

- As the cutting head contains a minimum number of individual components, it is particularly easy to handle while producing high-precision cuts.
- Important features are the low maintenance effort, the exact targeted cutting jet, the pre-filter protecting the orifice and the advanced nozzle valve design.
- The diamond orifice and the mixing chamber are combined in a single nozzle body. Both professional users and workers who have only recently been introduced to abrasive cutting benefit from the simple design of the unit as the focusing tube and the pre-filter, which are the only wear parts, can be exchanged easily and quickly.

ACTIVE AUTOLINE II	
Length	91 mm
Width	115 mm
Length Nozzle Tube	6"
Total height	448 mm
Weight	3 kg
HP connection	3/8" UNF
Mounting Screws (2x)	1/4" x 7/8"

ACTIVE IDE II	
Length	91 mm
Width	97 mm
Length Nozzle Tube	5,75"
Total height	448 mm
Weight	3,2 kg
HP connection	3/8" UNF
Mounting Screws (2x)	1/4" x 7/8"



Pump options

Redundant intensifier

Adding a redundant intensifier provides a completely identical high pressure production system to a high pressure pump. Activating the redundant system takes just a few minutes and maintains a continuous flow of maximum high pressure for continuous production. The option is well worth the investment for shops under tight production schedules and in need of continuous, reliable production from just one machine. It is nearly the equivalent to having two pumps in one, while consuming less space – and far less capital. Please ask us which pump models can be equipped with a redundant intensifier.

Proportional control

The Proportional Control enables automatic changes to the pressure generated by the pump, even mid-job, in order to maximize machine time and vary the cutting speed. It can dramatically reduce the complexity of cutting and the cutting time required, especially when working with fragile materials such as ceramic tile and glass. Using the Proportional Control, pressure can be lowered to one level for starting new holes, ramped up for cutting lines, and adjusted again for cutting curves. Pressure can be instantly adjusted to any level.

Ability to feed into one common network

Many companies expand their business year by year. If more capacity is required, additional STREAMLINE™ pumps can be connected in order to feed into one common network supplying several cutting stations with high pressure water. Step by step, you can increase productivity depending on your business' needs.

Pump networking with “Stroke Control”

Installing this option makes it possible to connect multiple pumps to a common high pressure

line for the ultimate in continuous production shops: a networked pump system where the pumps are monitored by the Stroke Control system. Exclusively available from KMT, it is the perfect tool for connecting multiple pumps and creating a much more reliable source of high pressure. The Stroke Control controls the output of each pump to be consistent with the size of the pump and proportional to the total load required from the pump network. With the Stroke Control, the stroke rate of each pump is monitored so the total system demand is distributed equally among all pumps. It is the ultimate in automated, reliable, high pressure production.

TELEDIAGNOSIS REMOTELINE

This option allows you to monitor the operating conditions of your system. Problems can be diagnosed and detailed information for the troubleshooting is being provided. To set up the Remote-Diagnosis, the control of the high pressure pump will only be connected to your IT-network. If necessary, you can grant KMT access to your pump control in order to get immediate support by one of our experts. In general, you can save costs and downtimes caused by the deployment of a service technician. Typically, there is no delay in production as REMOTELINE enables your system to be fully operational immediately after the diagnosis and the troubleshooting.

Additional tools and options

Tool and spare part kits as well as threading and coning tools are available to run your equipment most securely. Accessories such as closed loop cooling systems, waste water filtration, the BOOSTERLINE for the continuous water supply of high pressure pumps or water treatment systems can be supplied in accordance to the equipment installed.

Abrasive Bulk transfer system

ABRALINE

Production reliability requires constant monitoring of the entire cutting process. An economical and successful cutting process depends greatly on a constant abrasive flow rate. This fact becomes even more important when cutting brittle materials such as stone, marble or glass.

Abrasive flow monitoring saves time and costs

Our ABRALINE feeding system precisely monitors the availability of sufficient abrasive closely during the entire cutting process. This protects your valuable material from damage and saves unnecessary costs and time. Its concept assures process stability, security and a very high degree of reliability.

Two tanks for a continuous abrasive flow

The ABRALINE transfer system consists of a big silo for the abrasive and a smaller tank which lies directly underneath. This vessel contains abrasive sand pressurized by compressed air. The connected flexible hose guides the abrasive directly to the abrasive metering system of each cutting head. Additionally, the system features a control cabinet with a control relay which continuously monitors operating states and relays the corresponding signals to the pneumatic system and the control lights.

Sensors monitor abrasive availability

Both of the tanks contain level sensors in the sand exit slot areas. Their signals are constantly monitored in the control station located in the electrical cabinet. When the abrasive level in the vessel reaches its minimum, the respective sensor gives a signal to the control relay which then opens the valve at the vessel inlet to automatically refill the vessel with abrasive. If the abrasive level in the upper tank is lower than required, a warning light begins

to flash thus informing the operator to replenish the feeding hopper with abrasive sand.

The convenient solution for different demands

KMT offers the ABRALINE feeding system in two different sizes suitable for different requirements. The smaller version ABRALINE Comfort is sufficient for ensuring the abrasive feed for occasional cutting needs. For large cutting machines which operate continuously and with multiple cutting heads, we recommend the model ABRALINE Advanced.

ABRALINE		
	ADVANCED	COMFORT
Max. flow rate	4000 g/min	4000 g/min
Continuous Op. Press.	2-6 bar	2-6 bar
Supply voltage	115-240 V	115-240 V
Vessel volume	24 l	13 l
Silo volume	1 000 kg	250 kg
Length	1 060 mm	700 mm
Width	1 060 mm	700 mm
Net. Weight	250 kg	95 kg



Abrasive Metering System

FEEDLINE

Stable and repeatable operating parameters are a fundamental requirement for high-quality water-jet cutting. This applies in particular to abrasive applications used to cut brittle materials, where a constant flow of abrasive is simply a must. KMT WATERJET SYSTEMS responded to this demand by developing the FEEDLINE abrasive metering system. Controlled through a central CNC controller or a potentiometer, the FEEDLINE supplies the cutting head with the optimized flow of abrasive. This helps save material and costs.

The FEEDLINE technology

The FEEDLINE system supplies the cutting head with a constant metered quantity of abrasive. Without this controlled supply, the mixing chamber for abrasive, air and water would become clogged up. With the FEEDLINE, this is effectively prevented. It feeds a metered flow of abrasive by means of compressed air into a 0.8-litre transfer tank. At the base of the tank, the abrasive collects on the metering and transfer wheel whose rotational speed determines the feed rate to the cutting head.



Lower costs thanks to accurate control

It requires different quantities of abrasive to cut different materials. The thicker the material, the more abrasive is needed. Accurate metering settings help lower operating costs especially in units used to cut many different materials on a daily basis. The adjustment range of the FEEDLINE caters for flow rates of 0 to 1,000 g per minute. Greater quantities can be catered for by changing a shim.

FEEDLINE	
Flow rate (adjustable)	0-1 000 g/min
Operating voltage	24 VDC
Control voltage	0-10 V / 4-20 V
Net Weight	3,1 kg
Length	124 mm
Width	130 mm
Height	470 mm

ABRASIVE MANAGEMENT SYSTEM

The abrasive metering system FEEDLINE is also available in the attractive AMS package, which additionally includes one or more abrasive cutting heads and the ABRALINE thus representing the simple complete solution for the abrasive feed.

Abrasive Metering System

Feedline Precision

Variable Control Dial for Precision and Flexibility

An accurate and consistent abrasive feed-rate is critical to the waterjet abrasive cutting process. A well regulated feed-rate of abrasive cuts down on waste and results in a tighter cutting stream with a cleaner, smoother cutting edge.

KMT Knows Accuracy & Precision

The FEEDLINE PRECISION Abrasive Metering System is designed with the same precision engineering KMT Waterjet has been globally known for since 1971 when they invented the first waterjet cutting system.

Ease of Use & Maintenance

The KMT FEEDLINE PRECISION is simple to mount, operate and maintain. The gravity fed abrasive automatically feeds to the fill line. No need to pause the cutting process-- the abrasive feed-rate can be adjusted to increase or decrease the abrasive stream. Adjusting the abrasive feed is quickly done by the operator with a turn of the knob to the correct setting.

Flexibility in Abrasive Use & Cutting Speed

The KMT FEEDLINE PRECISION features an accurate dial with multiple settings, from 0 to 2-1/2 lbs./min., which allow the operator to quickly select the amount of abrasive needed to improve cutting speed. The orifice setting is easily viewed by the operator at any time.

Compact & Lightweight

The KMT FEEDLINE PRECISION measures approximately 13.03" x 5.17" and is constructed of primarily lightweight, durable non-metallic composites that will not corrode in most environments.

Designed to Minimize Down Time

The KMT FEEDLINE PRECISION features tightly sealed O-rings at the top and bottom of the abrasive housing, as well as the metering assembly to prevent moisture from contaminating the abrasive. The abrasive outlet feed is designed to help inhibit water from entering the housing and cause slowing, or possible clogging, of abrasive feed and the metering assembly is removable for easy cleaning.

The KMT Waterjet Family of Products

The FEEDLINE PRECISION is designed to work with the complete line of KMT Waterjet cutting head components and the STREAMLINE™ SL-V line of pumps, including the new, fastest cutting STREAMLINE™ PRO 100,000 PSI pump. Please call to discuss your applications or to receive more information on any high pressure component. KMT Waterjet has a network of trained and certified technicians available to provide Cutting Edge Solutions.

Summary of Features

- **KMT FEEDLINE PRECISION:** Simplicity and Flexibility for Performance Value.
- **Operational Ease:** The FEEDLINE PRECISION from KMT is a performance value abrasive feeder that can be adjusted while cutting for maximum efficiency.
- **Cutting Flexibility:** Large, easy to read variable dial control knob is notched in 1/10 lb./min. increments for precision control - operator can quickly determine the amount of abrasive needed to improve cutting speed.
- **Consistent Accuracy:** Hardened orifice components minimize changes in feed-rate over time due to orifice wear.
- **Simplified Technology:** Gravity feed design close to the KMT Autoline™ or IDE™ cutting heads eliminates abrasive waste.
- **Non-Metallic Design:** Lightweight, durable nonmetallic construction for easy cleaning and corrosion resistance. Clear 360 degree viewing of abrasive for easy monitoring.
- **Wear Components:** Air cylinder rod shielded to minimize wear from abrasive. Fast and easy part replacement. Fast and easy cleaning, no tools required for day-to-day maintenance.



Dial-It-In Abrasive Control Knob
Notched in 1/10 lb. increments for precision control



Legend

- 1 - Air Connection (Abrasive OFF)
- 2 - Air Connection (Abrasive ON)
- 3 - Abrasive Inlet
- 4 - Abrasive Housing
- 5 - Variable Dial Knob
- 6 - Abrasive Housing Base
- 7 - Metering Assembly Knob
- 8 - Abrasive Outlet to Cutting Head

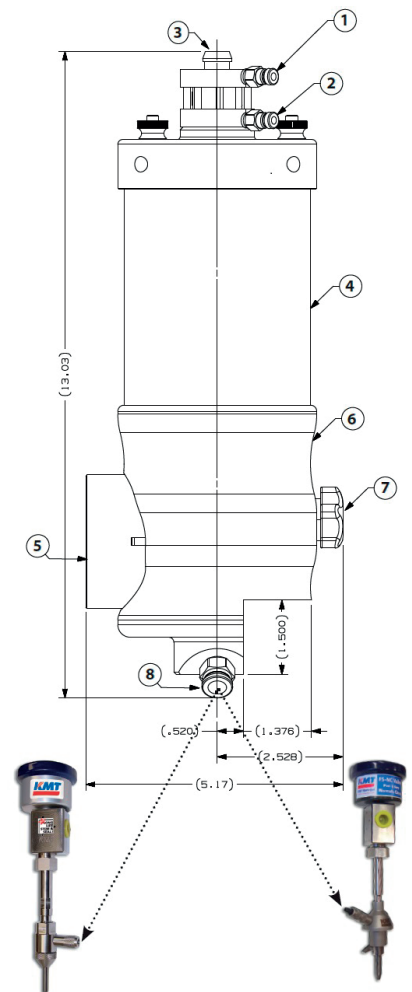

Cutting Water Supply System

BOOSTERLINE

The steady cutting water supply of high pressure pumps is a significant factor when it comes to the reliability and economic efficiency of a waterjet cutting machine. The BOOSTERLINE cutting water supply system is KMT's innovative solution to guarantee a constant inlet pressure of the cutting water for ultra-high pressure pumps.

Constant pressure ensures safety of production

The constant supply of water to the ultra-high pressure pump through the BOOSTERLINE system prolongs the service life of wear parts in the intensifier. The maintenance interval of the intensifier and the downtimes of the cutting unit are reduced as the high pressure pump is operated at ideal conditions.

STREAMLINE™ high pressure pumps should be operated at a constant inlet pressure of 3.5 bar. Where pressure fluctuations occur in the public water supply, the BOOSTERLINE water supply system guarantees a steady volume flow to the high pressure pump. The system is automatically switched on and off, depending whether the intensifier is activated or not. Thanks to the fully automated operation, the BOOSTERLINE is very easy to operate.

BOOSTERLINE	
Boosterline - Tank	
Weight	25 kg
Length	780 mm
Width	780 mm
Height	1600 mm
Boosterline - Pump	
Weight	10,4 kg
Length	191 mm
Width	504 mm
Height	217 mm
Voltage	230 V
Motor capacity	1,5 kW
Max. delivery height	45 m
Max. fluid quantity	7 m ³ /h
Max. operating temperature	40 °C

On the safe side with the 750 l water tank

A tank with a capacity of 750 liters ensures that there is always sufficient water available for your cutting application. The tank is made of nontransparent high-quality plastic, preventing the growth of algae, etc. Thanks to its compact design with a square base, the tank is easy to install. It guarantees continuous water supply to the high pressure pumps. If the quality of the water from the public supply does not meet the required standard, the BOOSTERLINE can be complemented with an upstream treatment unit.

Everything under control – sensor monitoring of the fill level

To optimize the fill level of the BOOSTERLINE, it is monitored with two sensors. When the maximum fill level in the tank is reached, a 230 V solenoid valve closes the water inlet to the tank. When the water level reaches its minimum, the control system switches off the BOOSTERLINE pump, thus preventing damage from dry running. The control unit is mounted on top of the tank and is operated at 230 V.



General description of CNC milling

A traditional but essential technology, the most widespread material processing even up to these days.

Our company has machines with automatic tool changing options and are operated by highly developed user-interfaces. The majority of the processes are completely automatic. As our operations work in a closed-circuit system, each desired working parameter can be followed during the whole process. This ongoing feedback guarantees the required sizes and optimal processing even at high serial numbers.

Fields of applications

- The manufacturing of light alloy parts
- Clamping device manufacturing
- Advertising and informational signs
- Woodwork
- Manufacturing metal parts



The complete milling equipment

PreciTrack® PTM2030

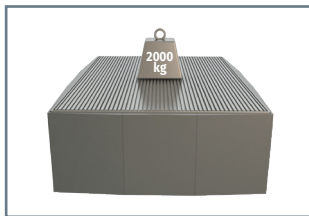
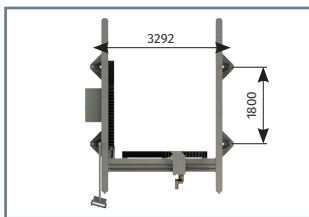
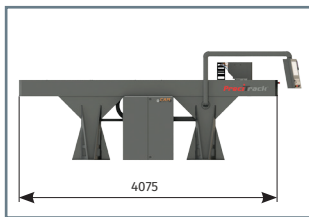
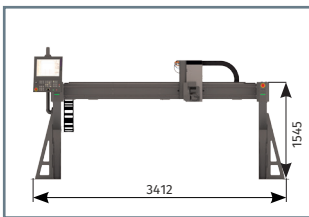

PreciTrack PTM2030 technical specifications

X Y Z Axis	3418x3850x1700 mm
Work area (x, y, z)	2000x3000 mm
Weight	~ 2000 kg
Load capacity	~ 2000 kg
Power	~ 14 kW
Drive	Digital AC servo
Rapid traverse speed X	60 m/min
Rapid traverse speed Y	60 m/min
Rapid traverse speed Z	30 m/min
Maximal step precision	0,003 mm
Operational step precision	0,01 mm
Retract precision	0,01 mm
Spindle type	Chopper 3300HSK S5
No. of milling head	1 pc
Max. spindle r.p.m.	30.000
Max. clamping diameter	13 mm
Tool change	automatic
Max. noise level	80 dB
Control	NCT201

We designed the complete unit above according to the industrial averages so it is an applicable solution for most manufacturers but if you have other production demands you can naturally order a different configuration, as well. Due to the PreciTrack coordinate track the size, technology and accessory units can be changed in a flexible way.

High performance spindles

Jäger Chopper spindles

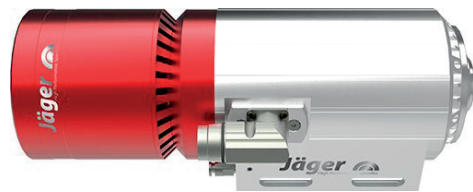

Chopper 1500 D		
Steel ball bearing (pieces)		2
Lifetime lubricated, maintenance free		
Rated power	S1-100%	1,5 kW
	S6-60%	1,9 kW
	Pmax. / 5s	4,1 kW
Voltage		200 V
Current	S1-100%	6 A
	S6-60%	7 A
Frequency		500 Hz
Motor poles (pairs)		1
Rated rotation speed		30 000/min
Motor protection		PTC
Motor		AC motor
Housing diameter		100 mm
T-slots		DIN 650-8
Cooling system		air cooled
Sealing air		yes
Tool change		pneumatic
Clamping range up to		8 mm
Collet type		10/5°
Clockwise rotation		yes
Cable		cable length: 3 m
Weight		7 kg
Inner taper run out		< 2 μ
Spindle holder integrated		yes

Chopper 1500 HSK S5A		
Steel ball bearing (pieces)		2
Lifetime lubricated, maintenance free		
Rated power	S1-100%	1,5 kW
	S6-60%	1,9 kW
	Pmax. / 5s	4,1 kW
Voltage		200 V
Current	S1-100%	6 A
	S6-60%	7 A
Frequency		500 Hz
Motor poles (pairs)		1
Rated rotation speed		30 000/min
Motor protection		PTC
Motor		AC motor
Housing diameter		100 mm
T-slots		DIN 650-8
Cooling system		air cooled
Sealing air		yes
Tool change		pneumatic
Taper cleaning		yes
Clamping range up to		10 mm
Clamping system		WK19
ESD protection / Contact by touch		yes
Coupler plug		9 fpin metal
Clockwise rotation		yes
Weight		7 kg
Inner taper run out		< 2 μ
Axial run-out		< 2 μ
Spindle holder integrated		yes

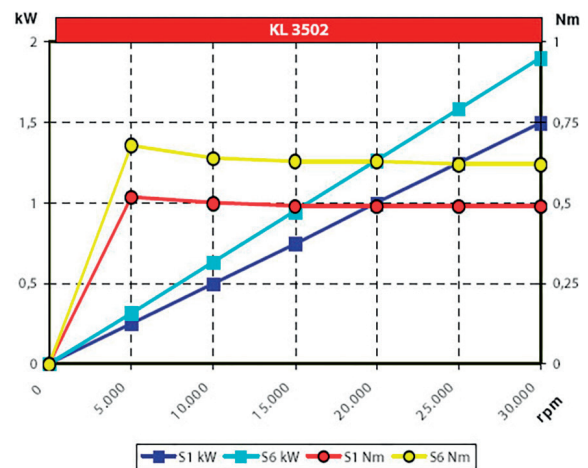
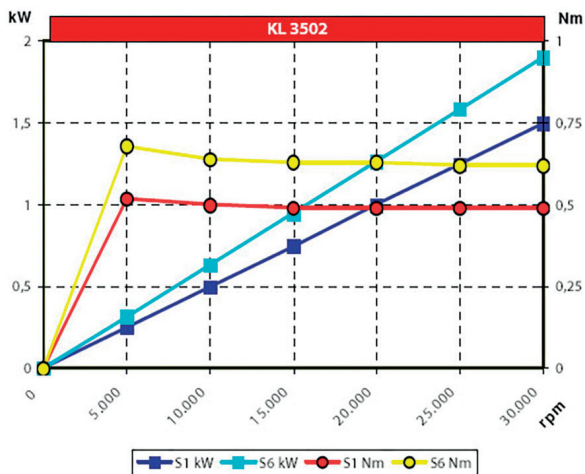

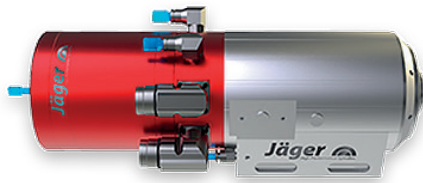

Chopper 2300-40 KS5A		
Ceramic hybrid ball bearing (pieces)		2
Lifetime lubricated, maintenance free		
Rated power	S1-100%	2,3 kW
	S6-60%	2,6 kW
	Pmax. / 5s	3,5 kW
Voltage		200 V
Current	S1-100%	9,5 A
	S6-60%	10 A
	Pmax. / 5s	12 A
Frequency		667 Hz
Motor poles (pairs)		1
Rated rotation speed		40 000/min
Speed monitoring		Transmitter
Motor protection		PTC
Motor		AC motor
Housing diameter		100 mm
T-slots		DIN 650-8
Cooling system		liquid cooled
Sealing air		yes
Tool change		pneumatic
Taper cleaning		yes
Clamping range up to		10 mm
Clamping system		WK 19
Tool change monitoring, 1 positions		inductive, clamped
ESD protection / Contact by touch		yes
Coupler plug (motor phases)		9 pin metal
Coupler plug (sensors)		12 pin metal
Clockwise rotation		yes
Weight		7 kg
Inner taper run out		< 2 μ
Spindle holder integrated		yes

Chopper 3300 HSK S5A		
Steel ball bearing (pieces)		3
Lifetime lubricated, maintenance free		
Rated power	S1-100%	3,3 kW
	S6-60%	4,5 kW
	Pmax. / 5s	7,5 kW
Voltage		380 V
Current	S1-100%	6,9 A
	S6-60%	9,1 A
	Pmax. / 5s	19 A
Frequency		500 Hz
Motor poles (pairs)		1
Rated rotation speed		30 000/min
Motor protection		PTC
Motor		AC motor
Housing diameter		100 mm
T-slots		DIN 650-8
Cooling system		fan cooled
Sealing air		yes
Tool change		pneumatic
Taper cleaning		yes
Clamping range up to		13 mm
Clamping system		HSK-E32
ESD protection / Contact by touch		yes
Coupler plug		9 pin metal
Clockwise rotation		yes
Weight		9,4 kg
Inner taper run out		< 2 μ
Spindle holder integrated		yes

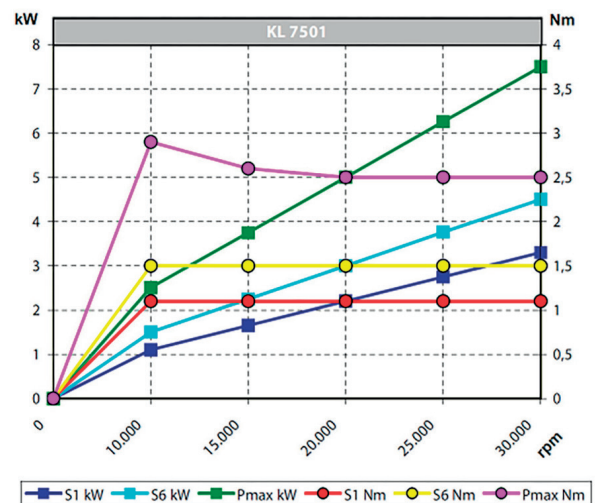
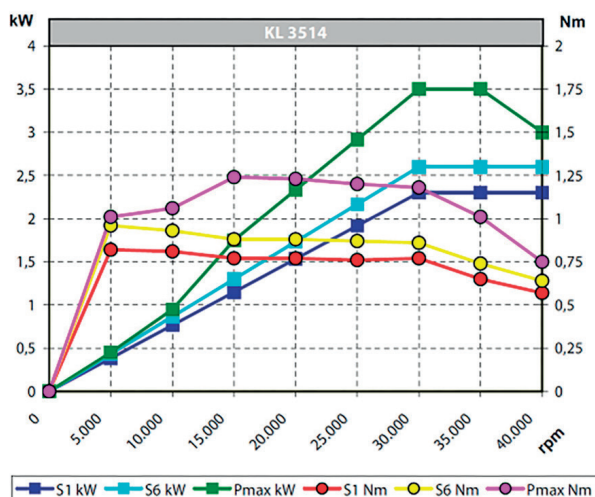



Chopper 5000 HSK S5		
Steel ball bearing (pieces)		3
Lifetime lubricated, maintenance free		
Rated power	S1-100%	5 kW
	S6-60%	6,5 kW
	Pmax. / 5s	7,5 kW
Voltage		380 V
Current	S1-100%	10 A
	S6-60%	12 A
	Pmax. / 5s	13,9 A
Frequency		500 Hz
Motor poles (pairs)		1
Rated rotation speed		30 000/min
Speed monitoring		Transmitter
Motor protection		PTC
Motor		AC
Housing diameter		100 mm
T-slots		DIN 650-8
Cooling system		liquid cooling
Sealing air		yes
Taper cleaning		yes
Tool change		pneumatic
Clamping system		HSK-E 32
Tool change monitoring		inductive
1 position		clamped
Clamping range up to		13 mm
Clockwise rotation		yes
Coupler plug (motor phases)		9 pin metal
Coupler plug (sensors))		12 pin metal
Weight		9,4 kg
Inner taper run out		< 2 μ
Spindle holder integrated		yes

Chopper 6500 HSK		
Steel ball bearing (pieces)		4
Lifetime lubricated, maintenance free		
Rated power	S1-100%	6,5 kW
	S6-60%	8 kW
	Pmax. / 5s	9 kW
Voltage		380 V
Current	S1-100%	16 A
	S6-60%	18 A
	Pmax. / 5s	22 A
Frequency		800 Hz
Motor poles (pairs)		2
Rated rotation speed		24 000/min
Speed monitoring		Transmitter
Motor protection		PTC
Motor		AC
Housing diameter		142 mm
T-slots		DIN 650-10
Cooling system		fan cooled
Sealing air		yes
Tool change		pneumatic
Tool change monitoring		inductive
2 position		clamped, ejected
Taper cleaning		yes
Clamping range up to		20 mm
Clamping system		HSK-F 63
ESD protection / Contact by touch		yes
Coupler plug (motor phases)		9 pin metal
Coupler plug (sensors))		12 pin metal
Clockwise rotation		yes
Weight		27 kg
Inner taper run out		< 3 μ
Spindle holder integrated		yes

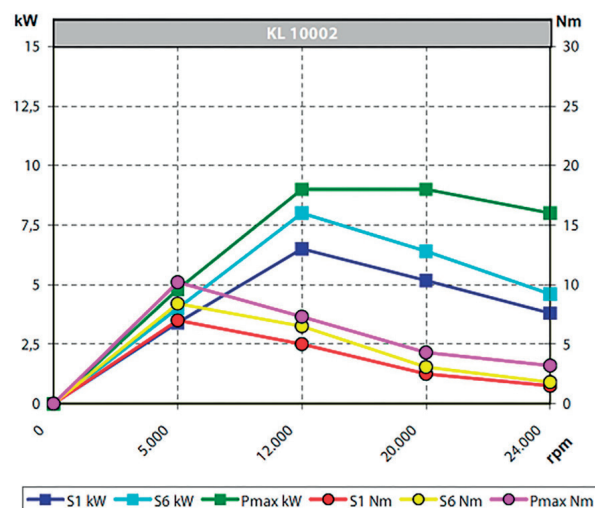
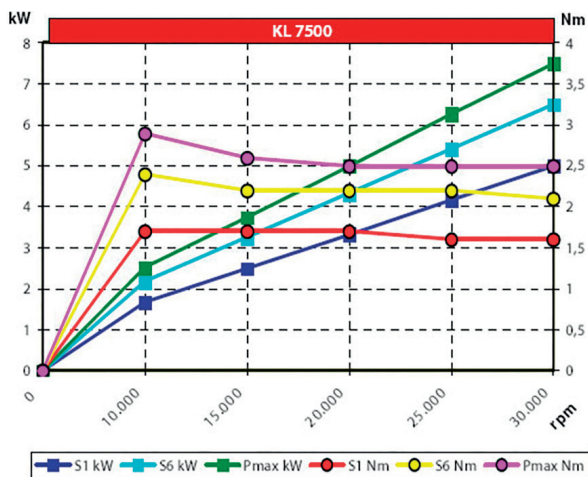



Chopper 6500 SK30

Steel ball bearing (pieces)		4
Lifetime lubricated, maintenance free		
Rated power	S1-100%	6,5 kW
	S6-60%	8 kW
	Pmax. / 5s	9 kW
Voltage		380 V
Current	S1-100%	16 A
	S6-60%	18 A
	Pmax. / 5s	22 A
Frequency		800 Hz
Motor poles (pairs)		2
Rated rotation speed		24 000/min
Speed monitoring		Transmitter
Motor protection		PTC
Motor		AC
Housing diameter		142 mm
T-slots		DIN 650-10
Cooling system		fan cooled
Sealing air		yes
Tool change		pneumatic
Tool change monitoring 2 position		inductive clamped, ejected
Taper cleaning		yes
Clamping range up to		20 mm
Clamping system		SK30
ESD protection / Contact by touch		yes
Coupler plug (motor phases)		9 pin metal
Coupler plug (sensors)		12 pin metal
Clockwise rotation		yes
Weight		27 kg
Inner taper run out		< 3 μ
Spindle holder integrated		yes

PowerLine ZS80-H445.06 S19W2/2

Ceramic hybrid ball bearing (pieces)		3
Lifetime lubricated, maintenance free		
Rated power	S1-100%	3,7 kW
	S6-60%	5 kW
	Pmax. / 5s	6,6 kW
Voltage		311 V
Current	S1-100%	9,5 A
	S6-60%	12,6 A
	Pmax. / 5s	15,4 A
Frequency		1 500 Hz
Motor poles (pairs)		2
Rated rotation speed		45 000/min
Speed monitoring		Transmitter
Motor protection		KTY
Motor		AC
Housing diameter		80 mm
Cooling system		liquid cooling
Sealing air		yes
Taper cleaning		yes
Tool change		pneumatic
Clamping system		HSK-E 25
Tool change monitoring 2 position		inductive clamped, ejected
Clamping range up to		10 mm
Clockwise rotation		yes
Coupler plug (motor phases)		9 pin metal
Coupler plug (sensors)		12 pin metal
Weight		6 kg
Inner taper run out		< 1 μ

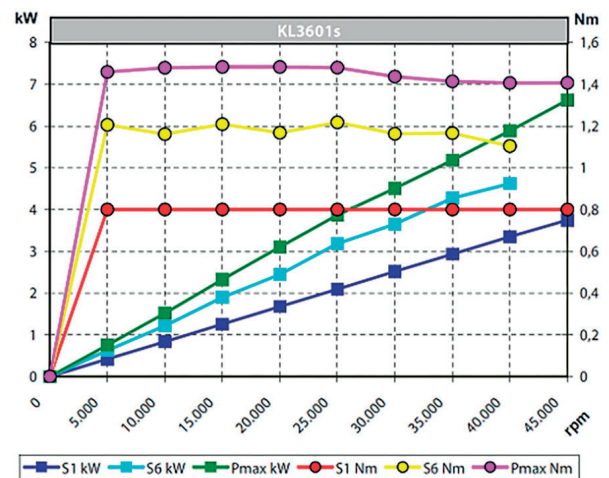
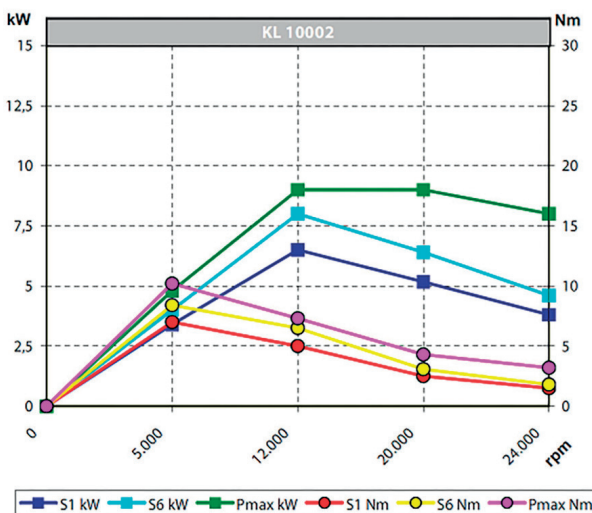



SK-Line S120-H542.21 S8W2		
Ceramic hybrid ball bearing (pieces)		4
Lifetime lubricated, maintenance free		
Rated power	S1-100%	4,4 kW
	S6-60%	5,4 kW
	Pmax. / 5s	7 kW
Voltage		380 V
Current	S1-100%	10 A
	S6-60%	12 A
	Pmax. / 5s	16 A
Frequency		1 400 Hz
Motor poles (pairs)		2
Rated rotation speed		42 000/min
Speed monitoring		Transmitter
Motor protection		PTC
Motor		AC
Housing diameter		120 mm
Cooling system		liquid cooling
Sealing air		yes
Taper cleaning		yes
Minimum quantity lubrication		pre-equipped
Tool change		pneumatic
Clamping system		HSK-E 32
Csatlakozás		kúpos adapter
Tool change monitoring		inductive
1 position		clamped
Clamping range up to		13 mm
Clockwise rotation		yes
Coupler plug		18 pin metal
Weight		18 kg
Inner taper run out		< 1 μ

Z-Line Z100-H540.08 S3W2		
Ceramic hybrid ball bearing (pieces)		4
Lifetime lubricated, maintenance free		
Rated power	S1-100%	5,5 kW
	S6-60%	8 kW
	Pmax. / 5s	12 kW
Voltage		380 V
Current	S1-100%	14,5 A
	S6-60%	19 A
	Pmax. / 5s	28 A
Frequency		1 333 Hz
Motor poles (pairs)		2
Rated rotation speed		40 000/min
Speed monitoring		Transmitter
Motor protection		PTC & KTY
Motor		AC
Housing diameter		100 mm
Cooling system		liquid cooling
Sealing air		yes
Taper cleaning		yes
Tool change		pneumatic
Clamping system		HSK-E 32
Tool change monitoring		inductive
3 position		clamped, kiengedett, ejected
Clamping range up to		13 mm
Clockwise rotation		yes
Coupler plug (motor phases)		8 pin metal
Coupler plug (sensors)		12 pin metal
Weight		13,5 kg
Inner taper run out		< 1 μ

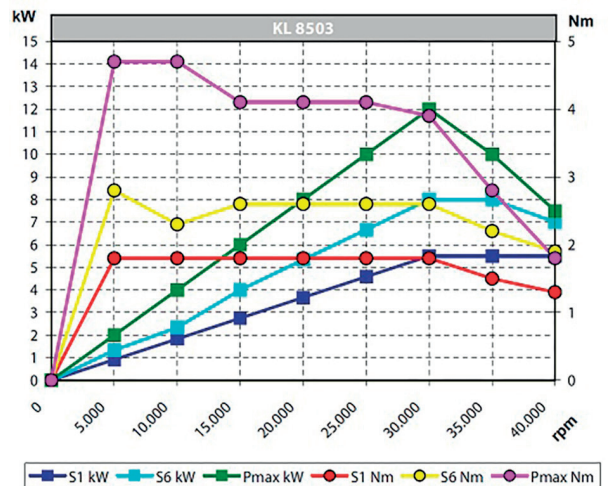
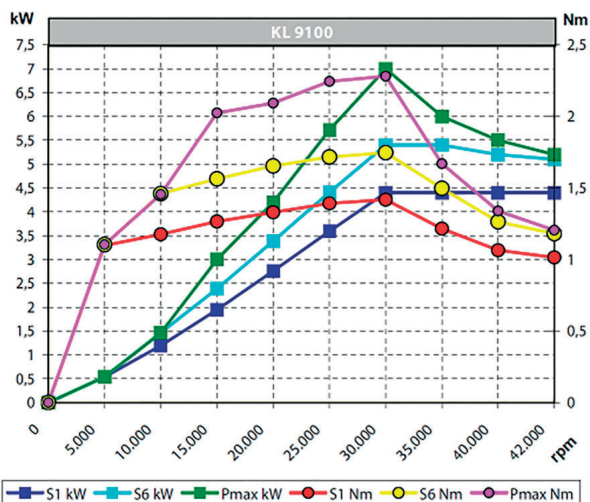

High performance spindles

HSD spindles

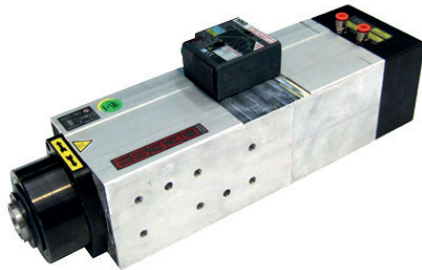

HSD ES330 - H6161090A6		
Rated power	S1-100%	4 kW
	S6-60%	4,5 kW
Voltage		380 V
Current	S1-100%	9 A
Frequency		800 Hz
Motor poles (pairs)		2
Rated rotation speed		24 000/min
Cooling system		air cooled
Weight		15 kg

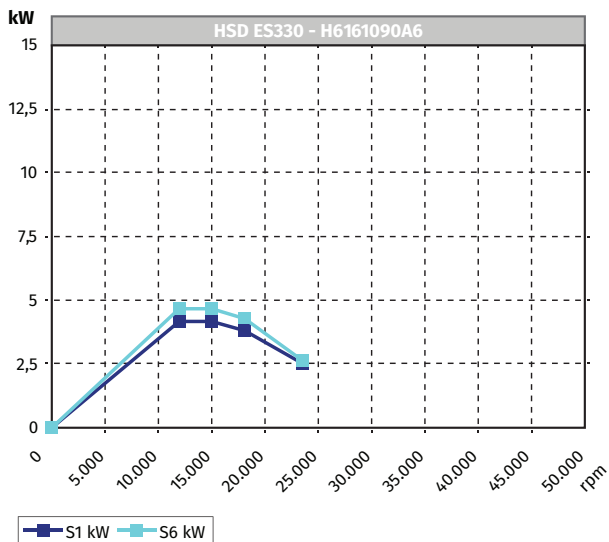

HSD ES915 - H6161H0461		
Rated power	S1-100%	3,8 kW
	S6-60%	4,6 kW
Voltage		380 V
Current	S1-100%	8,3 A
		10 A
Frequency		466 Hz
Motor poles (pairs)		1
Rated rotation speed		28 000/min
Cooling system		air cooled
Weight		21 kg

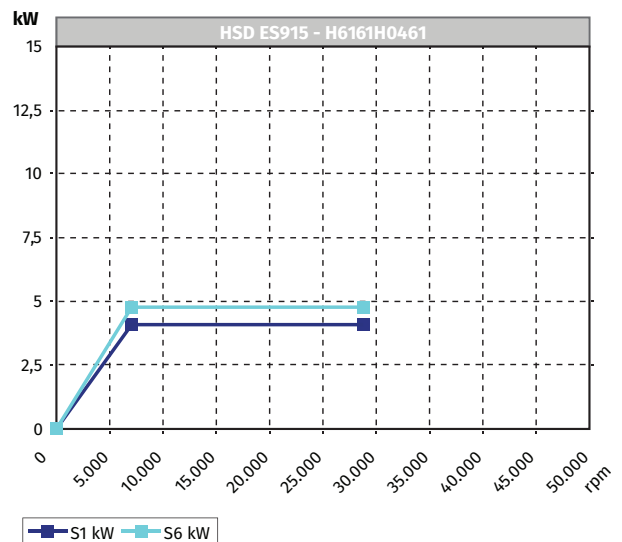



HSD ES915 - H6161H0464		
Rated power	S1-100%	3,8 kW
	S6-60%	4,6 kW
Voltage	380 V	
Current	S1-100%	8,3 A
		10 A
Frequency	466 Hz	
Motor poles (pairs)	1	
Rated rotation speed	28 000/min	
Cooling system	air cooled	
Weight	26 kg	



HSD ES915 - H6161H0380		
Rated power	S1-100%	5 kW
	S6-60%	6 kW
Voltage	380 V	
Current	S1-100%	12 A
		14 A
Frequency	933 Hz	
Motor poles (pairs)	2	
Rated rotation speed	28 000/min	
Cooling system	air cooled	
Weight	21 kg	

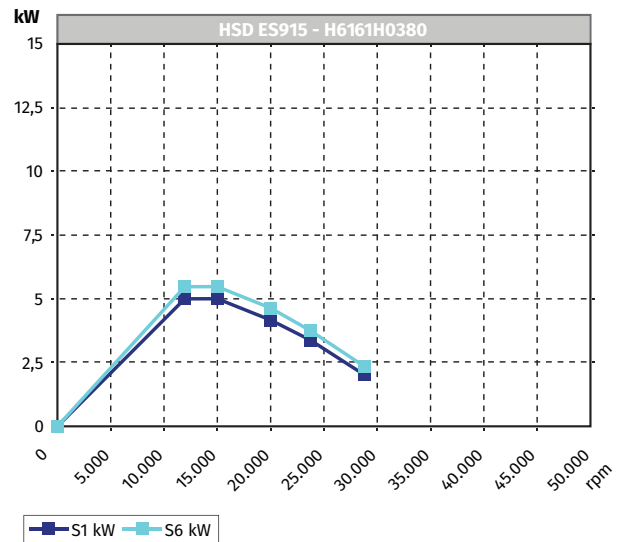
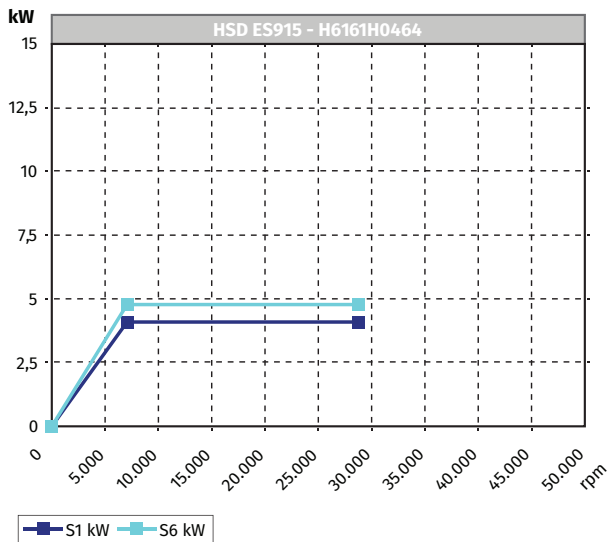

HSD ES929 - H6161H0824		
Rated power	S1-100%	7,5 kW
	S6-60%	9 kW
Voltage	380 V	
Current	S1-100%	15,7 A
		19 A
Frequency	800 Hz	
Motor poles (pairs)	2	
Rated rotation speed	24 000/min	
Cooling system	air cooled	
Weight	28 kg	

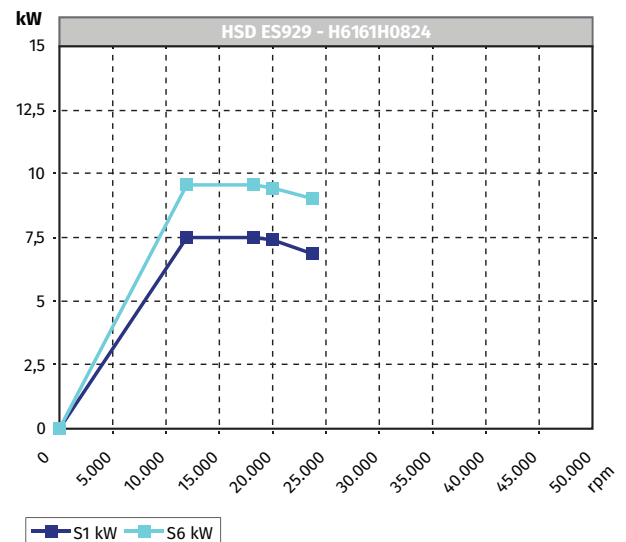



HSD ES929 - H6161H0822		
Rated power	S1-100%	7,5 kW
	S6-60%	9 kW
Voltage		380 V
Current	S1-100%	15,7 A
	S6-60%	19 A
Frequency		800 Hz
Motor poles (pairs)		2
Rated rotation speed		24 000/min
Cooling system		air cooled
Weight		33 kg



HSD ES929 - H6161H0766		
Rated power	S1-100%	10 kW
	S6-60%	12 kW
Voltage		380 V
Current	S1-100%	20 A
	S6-60%	24 A
Frequency		933 Hz
Motor poles (pairs)		2
Rated rotation speed		28 000/min
Cooling system		air cooled
Weight		31 kg

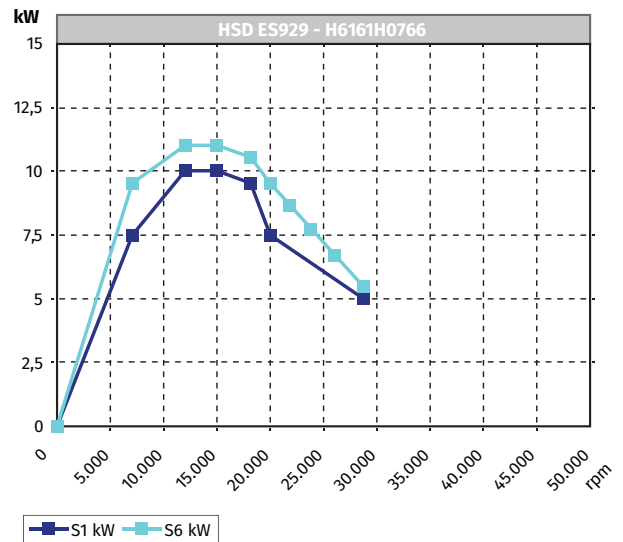
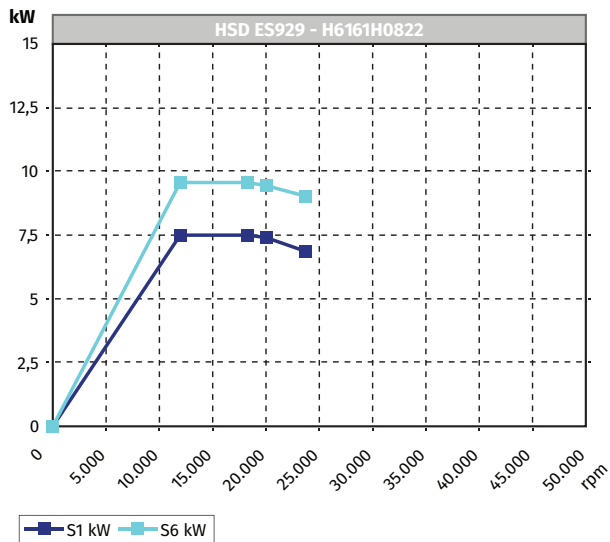

HSD ES929 - H6161H0892		
Rated power	S1-100%	12 kW
	S6-60%	14,4 kW
Voltage		380 V
Current	S1-100%	25 A
	S6-60%	30 A
Frequency		933 Hz
Motor poles (pairs)		2
Rated rotation speed		28 000/min
Cooling system		liquid cooled
Weight		34 kg

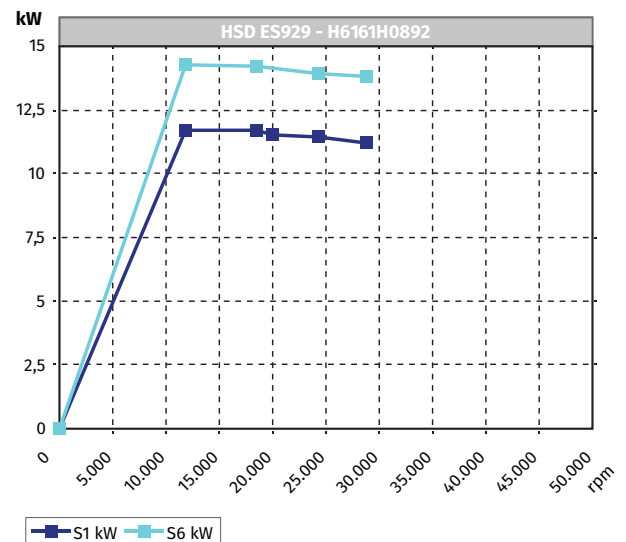

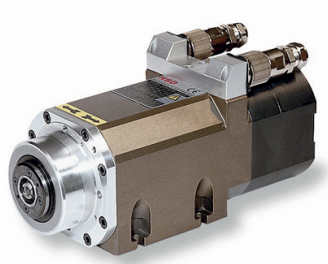

HSD ES325 - H6161H0361		
Rated power	S1-100%	2 kW
	S6-60%	2,4 kW
Voltage	380 V	
Current	S1-100%	5 A
	S6-60%	6 A
Frequency	833 Hz	
Motor poles (pairs)	1	
Rated rotation speed	50 000/min	
Cooling system	liquid cooled	
Weight	14 kg	

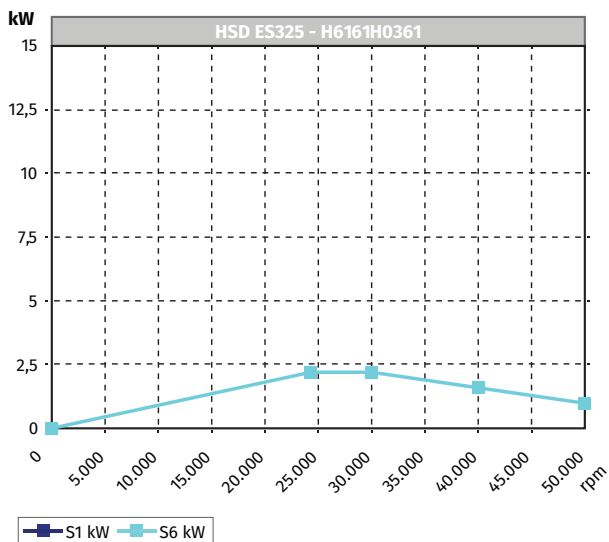



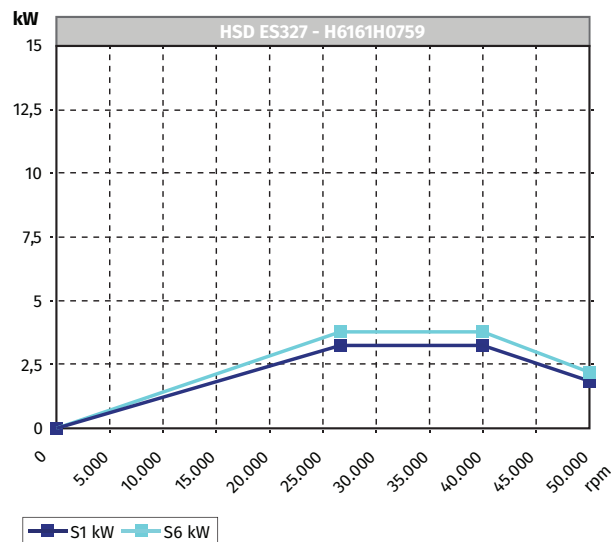

HSD ES327 - H6161H0759		
Rated power	S1-100%	3 kW
	S6-60%	3,6 kW
Voltage	380 V	
Current	S1-100%	8 A
	S6-60%	9,6 A
Frequency	1667 Hz	
Motor poles (pairs)	2	
Rated rotation speed	50 000/min	
Cooling system	liquid cooled	
Weight	8 kg	



Notes

A series of horizontal dotted lines for writing notes.

Cutable materials	 Flame cutting	 Laser cutting	 Milling	 Plasma cutting	 Waterjet cutting
Mild steel	X	X	X	X	X
Carbon steel	X	X		X	X
Stainless Steel		X		X	X
Aluminium		X	X	X	X
Titanium		X	X	X	X
Chrome and cobalt alloy		X		X	X
Copper		X	X	X	X
Bronz		X		X	X
Zink		X		X	X
Plexi		X	X		X
Polycarbonate			X		X
Foamed materials		X	X		X
PVC			X		X
PET		X	X		X
Other plastics		X	X		X
Rubber					X
Wood		X	X		X
Marble, Terazzo			X		X
Granit					X
Glass					X

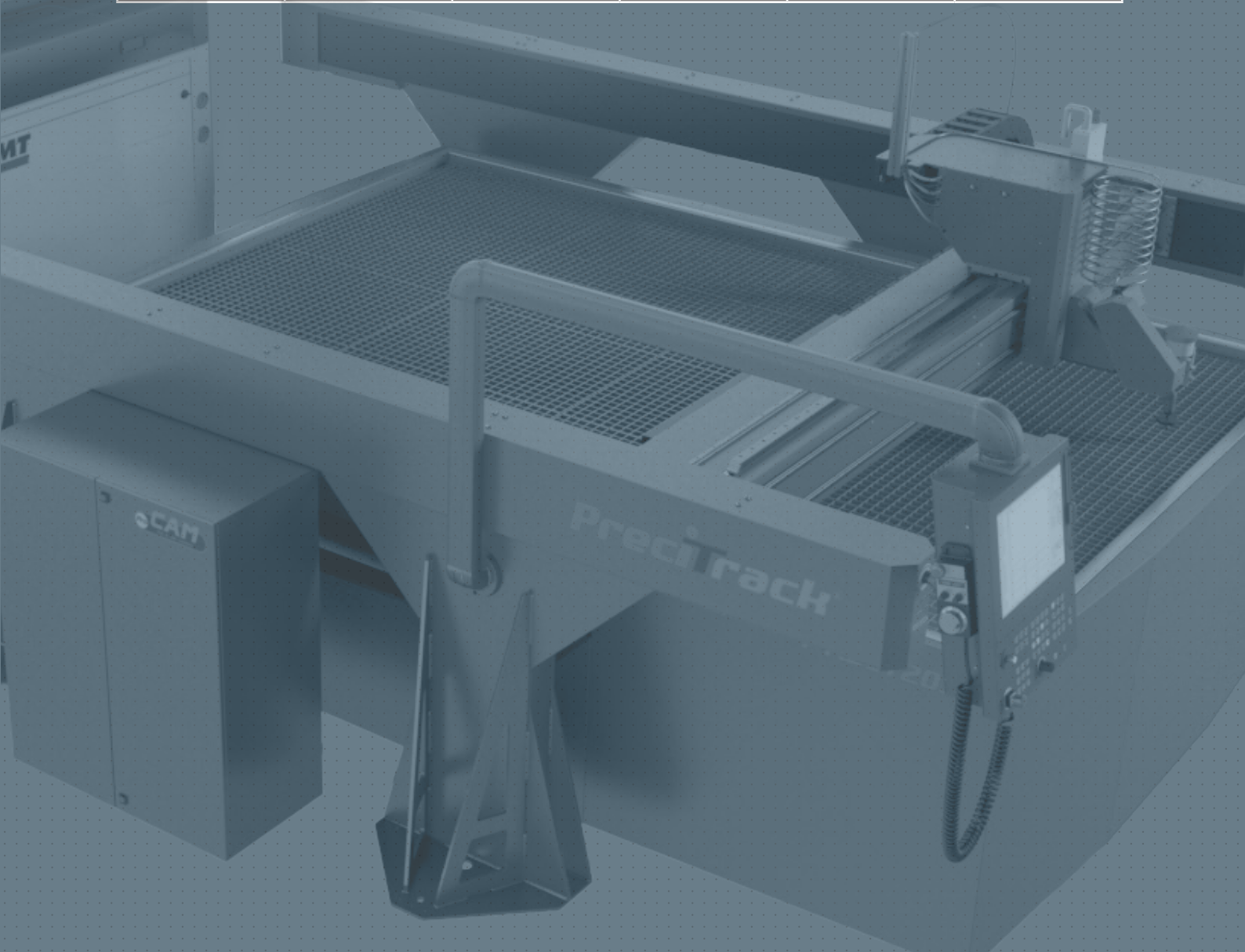



PreciTrack[®]
coordinate system

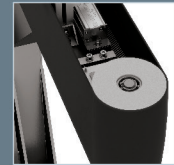
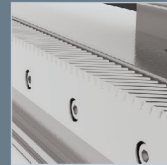
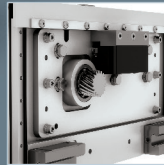

ProCAM Engineering and Development Ltd.

Factory Hungary-2142 Nagytarcsa, Ganz Ábrahám utca 4.
Office Hungary-2142 Nagytarcsa, Ady Endre u. 36/A.
Phone/Fax +36 28 737 046
E-mail info@procamkft.hu
Internet www.precitrack.com